



PRECISION BRAND®



Shim and Toolroom Products

www.precisionbrand.com

NEW!

New products in this catalog

✓ Customer recommended "Good Idea Products"

- Heat Treating Sheets
✓ (page 5)



- Lubricants
(page 18)



- Metric Feeler Gage
(page 21)



- Custom Shims
(page 31)

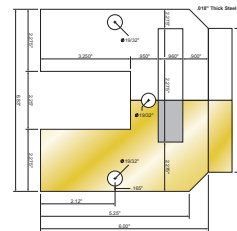

- Wedgies™ Installation Shims
✓ (page 34)

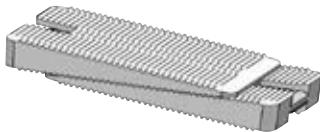

- Stainless Steel Arbor Shims
(page 38)



- Metric Die Button Shims
(page 42)



- Metric Shoulder Screw/Stripper Bolt Shims
(page 44)



- WaveSeal 360™ Hose Clamps
(page 51)



- Unicoil™ Hose Benders
✓ (page 52)



Precision Brand Products, Inc.... Much more than Shim Stock!
Over 65 years in Business!

Visit our NEW website for complete and up-to-date product information, product videos, testimonials and more!



w w w . p r e c i s i o n b r a n d . c o m

Precision Brand Products, Inc. is a subsidiary of Precision Steel Warehouse, Inc.

Contents

Arbor Spacers & Shims	39	Layout Fluid	15
Arbor Shim Assortment Kits	40	Brite-Mark® Medium Markers	15
Laminated Brass Arbor Shims	37	Layout Fluid Remover	15
Laminated Stainless Steel Arbor Shims	37	Lubricants	
Plastic Arbor Shims	41	SLIP Plate® Dry-Film Lubricant	18
Stainless Steel Arbor Shims	38	Superflake™	19
Blackeners		Tube-O-Lube®	19
ABC Blackener™	18	Maintenance Kits	2
Tool Black®	17	Measurement Conversion Chart	59
Coupling Nuts	55	Punch & Die Sets	11
Drill Rod	56	“METRIC 10” TruPunch®	11
Oil Hardening	56	“THE BIG” TruPunch™	11
Water Hardening	56	Punch & Die Stand	12
Feeler Gage	20	TruPunch®	11
Brass Poc-Kit® Assortment	24	Scrubs	16
Brass Thickness Gage	24	Shim	
Metric Steel Feeler Gage	21	6" & 8" Slotted Shim	33
Metric Steel Feeler Gage Assortment	22	Aluminum Shim Stock	30
Plastic Thickness Gage Assortments	23	Blue Tempered Shim Stock	30
Stainless Steel Poc-Kit® Assortment	23	Brass Shim Stock	28
Stainless Steel Thickness Gage	23	Color Coded Shim Stock	32
Steel Feeler Gage	20	Copper Shim Stock	30
Steel Feeler Gage Assortments	22	Custom Shims	31
Ground Flat Stock	45	Die Button Shims	42
Hi Spot	16	Laminated Shim	36
Hose Clamps		Metric Die Button Shims	42
316 Stainless Steel Hose Clamps	50	Metric Shoulder Screw/Stripper Bolt Shims	44
9/16" Band – Heavy Duty 3-Piece Hose Clamps	48	Metric Slotted Shim	35
9/16" Band – Heavy Duty 4-Piece Hose Clamps	49	Plastic Slotted Shim	35
All Stainless Military Hose Clamps	50	Shoulder Screw/Stripper Bolt Shims	43
Collared Screw Hose Clamps	48	Slotted Shim	33
Create-A-Clamp	52	Sof' Shoe® Shim	34
Critical Connection Hose Clamps	49	Stainless Steel Shim Stock	29
Miniature Series Hose Clamps	47	Steel Shim Stock Rolls	25
Quick Release Hose Clamps	52	Steel Shim Stock Sheets	26
Shielded/Lined Hose Clamps	47	Wedgies™ Installation Shims	34
Standard Series Hose Clamps	46	Threaded Rod	53
Unicoil™ Hose Benders/Supports	52	Alloy Materials	54
WaveSeal 360™ Hose Clamps	51	Electro Zinc Plated	53
Hot Melt Coating	10	Metric	55
Melting Pots	10	National Coarse Threads	53
Keystock		National Fine Threads	53
Metric Keystock	8	Plain Oil Finish	53
Mill Stock	7	Specialty Threaded Rod	54
Stainless Steel Keystock	7	Tool Wrap	5
Steel Keystock	6	Wire	13
Step Keystock	9	Music Wire	13
		Stainless Steel Wire	13

The quality products for industry shown in this catalog are sold under one or more of the following trademarks.

 <p>PRECISION BRAND®</p> <p>PRECISION PAK®</p> <p><i>Above trademarks are owned by Precision Steel Warehouse, Inc.</i></p>	 <p>ABC BLACKENER™ ABC SEALANT™ BRANDED® SHIM “THE BIG” POC-KIT® “THE BIG” TRU PUNCH™ DRI-SHIELD™</p> <p><i>Above trademarks are owned by Precision Brand Products, Inc.</i></p>	<p>DUPAGE® FIRST TRY® “METRIC 10” TRU PUNCH® MICRO SEAL® POC-KIT® PRE-CLEAN™ PREVENT® SOF' SHOE® TOOL BLACK® TRU PUNCH® WEDGIES™</p>	<p><i>Owned by ITW</i> Brite-Mark® Dykem® Hi-Spot™ Scrubs® Scrubs in a bucket® Steel Blue® Steel Red™</p>	<p><i>Owned by Superior Graphite</i> SLIP Plate® SLIP Plate® MowerGUARD™ SLIP Plate® Black ICE™ Superflake™ Tube-O-Lube®</p> <p><i>Owned by Unicoil International Pty, Ltd.</i> Unicoil™</p> <p><i>Owned by Ideal Clamp Products, Inc.</i> WaveSeal 360™</p>
--	---	--	---	--



Look for this symbol. It is displayed by products that are manufactured or stocked exclusively by Precision Brand Products, Inc.

Maintenance Kits

- Handy kits for shop toolroom or toolbox
- On hand when needed saves time and money
- Plastic compartment boxes are easy to store
- Bulk quantities also available



Cotter Pins

UPC No. 12905 – 600 Pcs.

Strong and flexible zinc plated steel pins with one prong extended for easy insertion and bending. Pins also have chisel point ends.



Contents

130	1/16" x 1"
100	1/8" x 1-1/4"
80	1/8" x 2"
150	3/32" x 1"
100	3/32" x 1-3/4"
40	5/32" x 2-1/2"



Stainless Steel Cotter Pins

UPC No. 12995 – 124 Pcs.

These pins are made from corrosion resistant stainless steel with one prong extended for easy insertion.



Contents

8	1/16" x 3/4"
8	1/16" x 1"
10	3/32" x 3/4"
12	3/32" x 1"
12	3/32" x 1-1/2"
8	3/32" x 2"
12	1/8" x 1"
8	1/8" x 1-1/4"
8	1/8" x 1-1/2"
10	1/8" x 2"
8	5/32" x 1-1/2"
8	5/32" x 2"
6	3/16" x 1-1/2"
6	3/16" x 2"



Clevis Pins

UPC No. 13965 – 83 Pcs.

Pins are made from cold formed low carbon steel. Plated finish extends life and chamfered hole allows for easy insertion.



Contents

6	3/16" x 1"	4	5/16" x 1-3/4"
7	1/4" x 1"	3	5/16" x 2"
4	1/4" x 1-1/4"	2	5/16" x 2-1/4"
7	1/4" x 1-1/2"	2	5/16" x 2-1/2"
4	1/4" x 1-3/4"	2	5/16" x 2-3/4"
6	1/4" x 2"	5	3/8" x 1"
3	1/4" x 2-1/4"	4	3/8" x 1-1/2"
3	1/4" x 2-1/2"	2	3/8" x 2"
6	5/16" x 1"	2	1/2" x 1-1/2"
4	5/16" x 1-1/4"	2	1/2" x 2"
5	5/16" x 1-1/2"		



Roll Pins

UPC No. 12925 – 300 Pcs.

Made of flexible spring steel, cold rolled, hardened and tempered. Chamfered ends simplify insertion.



Contents

1/16", 5/64", 3/32", 1/8", 5/32", 3/16", 7/32", 1/4", 5/16" & 3/8" diameters. Four lengths included for each diameter.



Metric Roll Pins

UPC No. 12960 – 287 Pcs.

Made of flexible spring steel, cold rolled, hardened and tempered. Chamfered ends simplify insertion. All sizes in millimeters.



Contents

1.5, 2, 3, 4, 5, 6, 8 and 10 millimeter diameters in various lengths from 6 to 80 millimeters.



Stainless Steel Roll Pins

UPC No. 12990 – 300 Pcs.

These stainless steel roll pins have chamfered ends for ease of insertion.



Contents

1/16", 3/32", 1/8", 3/16", 1/4", 5/16", 3/8" diameters. Various lengths included for each diameter.



O Rings

UPC No. 12930 – 300 Pcs.

Made of BUNA-N 70 durometer rubber compound. Creates a tight seal for fluid or gas connections.



Contents

140 pcs. of 1/16" body, 80 pcs. of 3/32" body and 80 pcs. of 1/8" body. Various sizes are included for each body size.



Metric O Rings

UPC No. 13995 – 350 Pcs.

Made of BUNA-N 70 durometer rubber compound. These metric size rings create a tight seal for fluid or gas connections.



Contents

125 pcs. of 2mm body, 95 pcs. of 2.5mm body and 130 pcs. of 3mm body. Various sizes are included for each body size.



Taper Pins

UPC No. 12907 – 100 Pcs.

Made from low carbon steel. These pins are mainly used for hole alignment in maintenance machinery. They are tapered 1/4" per foot.



Contents

#0, #1, #2, #3, #4, #5, and #6 sizes included. Available in various lengths from 3/4" to 3".



E-Clips

UPC No. 12910 – 265 Pcs.

External clips, made of carbon steel to retain positive retention of pulleys, sprockets, springs and bearings on shafts and rods.

Contents



30 1/8"	30 3/8"
20 5/32"	25 7/16"
30 3/16"	20 1/2"
20 7/32"	15 5/8"
30 1/4"	10 3/4"
30 5/16"	5 7/8"



Metric E-Clips

UPC No. 13990 – 255 Pcs.

External metric size clips made of steel, retain positive retention of pulleys, sprockets, springs and bearings on shafts and rods.

Contents



35 1.2mm	10 7mm
30 1.5mm	10 8mm
30 1.9mm	10 9mm
25 2.3mm	5 10mm
20 3.2mm	10 12mm
15 4mm	15 15mm
15 5mm	5 19mm
15 6mm	5 24mm



Dowel Pins

UPC No. 12912 – 176 Pcs.

Made from alloy steel, these pins have a plain finish and are used to retain parts in a fixed position or to preserve alignment when extreme accuracy is required.

Contents



Diameters: 1/16", 1/8", 3/16", 1/4", 5/16", 3/8" & 1/2". Available in various lengths from 3/8" to 2".



Housing Rings

UPC No. 12920 – 150 Pcs.

Internal rings with tapered design to maintain constant pressure to prevent slippage of axles, gears and bearings inside machinery housing. Made of zinc plated spring steel.

Contents



15 1/2"	10 1-1/16"
15 5/8"	10 1-1/8"
15 11/16"	10 1-1/4"
15 3/4"	5 1-3/8"
15 13/16"	5 1-1/2"
15 7/8"	5 1-5/8"
10 1"	5 1-3/4"



Metric Housing Rings

UPC No. 13985 – 218 Pcs.

Internal metric size rings with tapered design to maintain constant pressure to prevent slippage of axles, gears and bearings inside machinery housing. Made of black phosphate coated spring steel.

Contents



20 10mm	8 25mm
15 11mm	5 26mm
20 12mm	8 28mm
18 14mm	8 30mm
15 15mm	8 32mm
18 16mm	5 35mm
12 18mm	3 36mm
10 19mm	3 37mm
12 20mm	5 38mm
10 22mm	5 40mm
10 24mm	



Hitch Pin Clips

UPC No. 12915 – 150 Pcs.

Reusable, quick release pins for fast assembly and disassembly. Made of spring steel to maintain tension.

Contents



60 1/16"	#18
30 3/32"	#3
20 3/32"	#7
20 1/8"	#16
15 5/32"	#10
5 3/16"	#6



Snap Rings

UPC No. 12900 – 300 Pcs.

External, spring steel snap rings used to retain pulleys, gears or wheels on shafts. Made of zinc plated spring steel.

Contents



30 1/4"	30 5/8"
20 5/16"	35 3/4"
50 3/8"	10 13/16"
20 7/16"	20 7/8"
50 1/2"	10 1"
20 9/16"	5 1-1/4"



Metric Snap Rings

UPC No. 13980 – 295 Pcs.

External, metric size spring steel snap rings used to retain pulleys, gears or wheels on shafts. Made of black phosphate coated spring steel.

Contents



25 6mm	15 18mm
20 8mm	10 19mm
15 9mm	15 20mm
20 10mm	10 21mm
20 11mm	10 22mm
20 12mm	10 24mm
10 13mm	10 25mm
20 14mm	5 28mm
15 15mm	5 30mm
20 16mm	5 32mm
10 17mm	5 35mm



Retaining Rings

UPC No. 12935 – 140 Pcs.

Similar to housing rings, these external rings accommodate components with large chamfers and radii. Made of zinc plated spring steel.

Contents



20 1/2"	15 3/4"
20 9/16"	10 7/8"
20 19/32"	10 1"
20 5/8"	10 1-1/4"
15 11/16"	

Maintenance Kits



Set Screws

UPC No. 12950 – 200 Pcs.

High grade alloy steel set screws with hexagon recessed heads. Ends have cup points for positive torque.

Contents

- 10 6-32 x 3/16"
- 10 8-32 x 3/16"
- 10 10-24 x 1/4"
- 30 1/4-20 x 1/4"
- 20 1/4-28 x 1/4"
- 20 1/4-20 x 3/8"
- 30 5/16-18 x 3/8"
- 20 5/16-24 x 3/8"
- 20 5/16-18 x 1/2"
- 10 3/8-16 x 3/8"
- 10 3/8-24 x 3/8"
- 10 3/8-16 x 1/2"



Metric Set Screws

UPC No. 12975 – 375 Pcs.

High grade alloy steel metric set screws with hexagon recessed heads. Ends have cup points for positive torque.

Contents

- 25 M3 x 0.5mm x 3mm
- 25 M3 x 0.5mm x 6mm
- 25 M3 x 0.5mm x 10mm
- 25 M4 x 0.7mm x 4mm
- 25 M4 x 0.7mm x 6mm
- 25 M4 x 0.7mm x 10mm
- 25 M5 x 0.8mm x 5mm
- 25 M5 x 0.8mm x 8mm
- 25 M5 x 0.8mm x 12mm
- 25 M6 x 1.0mm x 6mm
- 25 M6 x 1.0mm x 8mm
- 25 M6 x 1.0mm x 10mm
- 25 M8 x 1.25mm x 8mm
- 25 M8 x 1.25mm x 12mm
- 25 M8 x 1.25mm x 16mm



Stainless Steel Set Screws

UPC No. 13935 – 220 Pcs.

These stainless steel set screws have hexagon recessed heads and cup points ends for positive torque.

Contents

- 5 4-40 x 3/16"
- 10 6-32 x 3/16"
- 5 6-32 x 1/4"
- 10 8-32 x 3/16"
- 5 8-32 x 1/4"
- 10 10-24 x 1/4"
- 5 10-32 x 1/4"
- 5 10-32 x 3/8"
- 25 1/4-20 x 1/4"
- 20 1/4-20 x 3/8"
- 5 1/4-20 x 1/2"
- 20 1/4-28 x 1/4"
- 25 5/16-18 x 3/8"
- 20 5/16-18 x 1/2"
- 20 5/16-24 x 3/8"
- 10 3/8-16 x 3/8"
- 10 3/8-16 x 1/2"
- 10 3/8-24 x 3/8"



Socket Head Cap Screws

UPC No. 12970 – 190 Pcs.

High grade alloy steel socket head screws with hexagon recessed heads.

Contents

- 10 6-32 x 1/2"
- 10 6-32 x 1"
- 10 8-32 x 1/2"
- 10 8-32 x 3/4"
- 10 8-32 x 1"
- 10 10-32 x 1/2"
- 10 10-32 x 3/4"
- 10 10-32 x 1"
- 10 10-24 x 1/2"
- 10 10-24 x 1"
- 10 1/4-20 x 1/2"
- 10 1/4-20 x 3/4"
- 10 1/4-20 x 1"
- 10 1/4-20 x 1-1/4"
- 10 1/4-20 x 1-1/2"
- 10 1/4-28 x 3/4"
- 10 1/4-28 x 1"
- 10 1/4-28 x 1-1/4"
- 10 1/4-28 x 1-1/2"



Metric Socket Head Cap Screws

UPC No. 12980 – 255 Pcs.

High grade alloy steel metric cap screws with hexagon recessed heads.

Contents

- 25 M4 x 0.7mm x 10mm
- 25 M4 x 0.7mm x 12mm
- 25 M4 x 0.7mm x 20mm
- 25 M4 x 0.7mm x 25mm
- 25 M5 x 0.8mm x 12mm
- 25 M5 x 0.8mm x 20mm
- 10 M5 x 0.8mm x 25mm
- 10 M5 x 0.8mm x 30mm
- 10 M6 x 1.0mm x 12mm
- 10 M6 x 1.0mm x 20mm
- 10 M6 x 1.0mm x 25mm
- 10 M6 x 1.0mm x 30mm
- 10 M6 x 1.0mm x 40mm
- 10 M8 x 1.25mm x 20mm
- 10 M8 x 1.25mm x 25mm
- 10 M8 x 1.25mm x 30mm
- 3 M8 x 1.25mm x 40mm
- 2 M8 x 1.25mm x 45mm



Machinery Keys

UPC No. 12955 – 58 Pcs.

Zinc plated steel, square keys have smooth corners for easy insertion into keyways.

Contents

- 3 1/8" x 1/8" x 3/4"
- 3 1/8" x 1/8" x 1"
- 5 3/16" x 3/16" x 3/4"
- 5 3/16" x 3/16" x 1"
- 5 3/16" x 3/16" x 1-1/4"
- 5 1/4" x 1/4" x 3/4"
- 5 1/4" x 1/4" x 1-1/4"
- 5 1/4" x 1/4" x 1-1/2"
- 5 5/16" x 5/16" x 1-1/4"
- 5 5/16" x 5/16" x 1-1/2"
- 5 3/8" x 3/8" x 1-1/4"
- 5 3/8" x 3/8" x 1-1/2"
- 2 1/2" x 1/2" x 1-1/2"



Grease Fittings

UPC No. 12945 – 90 Pcs.

These push type, plated fittings permit lubricant to flow while built-in ball, under spring pressure, prevents dirt from entering.

Contents

- 30 1/4" 28-Straight
- 10 1/4" 28-45°
- 10 1/4" 28-90°
- 30 1/8" NPT-Straight
- 5 1/8" NPT-45°
- 5 1/8" NPT-90°



Metric Grease Fittings

UPC No. 13975 – 95 Pcs.

These metric size, push type, plated fittings permit lubricant to flow while built-in ball, under spring pressure, prevents dirt from entering.

Contents

- 20 6mm x 1mm x Straight
- 10 6mm x 1mm x 45°
- 10 6mm x 1mm x 90°
- 20 8mm x 1mm x Straight
- 10 8mm x 1mm x 45°
- 10 8mm x 1mm x 90°
- 5 10mm x 1mm x Straight
- 5 10mm x 1mm x 45°
- 5 10mm x 1mm x 90°



Electrical Terminals

UPC No. 12985 – 175 Pcs.

High quality terminals and connectors for industrial and automotive applications.

Contents

- 30 Butt Connectors
- 20 Insulated Quick Slide Terminals
- 20 Non-insulated Quick Slide Terminals
- 5 Self-Splicing Connectors
- 40 Spade Terminals
- 60 Ring Terminals



Maintenance Kits



Woodruff Keys UPC No. 12940 – 250 Pcs.

Precise, zinc plated steel keys used for pulleys and drive shaft applications.



Contents

10 1/16" x 3/8"	5 3/16" x 5/8"
20 3/32" x 3/8"	20 1/8" x 3/4"
10 1/8" x 3/8"	10 5/32" x 3/4"
10 1/16" x 1/2"	20 3/16" x 3/4"
20 3/32" x 1/2"	5 1/4" x 3/4"
20 1/8" x 1/2"	5 5/32" x 7/8"
10 3/32" x 5/8"	5 3/16" x 7/8"
30 1/8" x 5/8"	5 7/32" x 7/8"
40 5/32" x 5/8"	5 1/4" x 7/8"



Stainless Steel Woodruff Keys UPC No. 13970 – 66 Pcs.

Precise, stainless steel keys used for pulley and drive shaft applications where corrosion resistance is a factor.



Contents





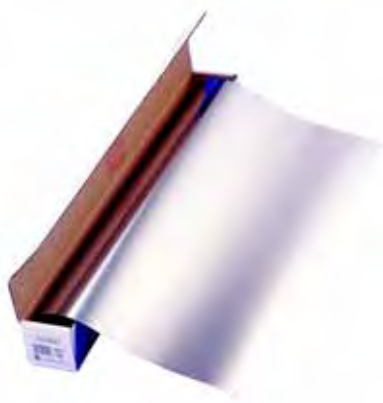

5 1/16" x 3/8"	4 3/16" x 5/8"
5 3/32" x 3/8"	4 1/8" x 3/4"
5 1/8" x 3/8"	4 5/32" x 3/4"
5 1/16" x 1/2"	4 3/16" x 3/4"
5 3/32" x 1/2"	4 1/4" x 3/4"
5 1/8" x 1/2"	3 3/16" x 7/8"
4 1/8" x 5/8"	3 1/4" x 7/8"
4 5/32" x 5/8"	2 1/4" x 1"

Tool Wrap



- PRECISION BRAND Tool Wrap is made of Type 321, or Type 309, soft annealed, stainless steel
- Helps protect from scale and oxide buildup during heat treating in atmospheric furnaces
- Eliminates decarburization buildup
- Protects the surface of air hardening tool steels
- Cut-to-fit stainless steel tool wrap creates an airtight envelope around your part
- Can be cut, folded and crease-sealed with ease
- 321 can be used in furnaces up to 2000°F (1093°C)
- 309 can be used in furnaces up to 2240°F (1227°C)
- Realize the benefits of a vacuum furnace at a fraction of the cost
- Also available in 12" x 24" stainless sheets

Stainless Steel Tool Wrap

Description	UPC No.	Lb. Wgt.
Approx. 24" wide x 50' long x .002" thick 321 Stainless	20110	9.00
Approx. 24" wide x 100' long x .002" thick 321 Stainless	20210	17.50
 Approx. 20" wide x 50' long x .002" thick 321 Stainless	20425	7.50
 Approx. 20" wide x 100' long x .002" thick 321 Stainless	20450	15.00
Approx. 12" wide x 50' long x .002" thick 321 Stainless	20310	5.25
Approx. 12" wide x 100' long x .002" thick 321 Stainless	20410	9.25
 Approx. 10" wide x 50' long x .002" thick 321 Stainless	20225	4.55
 Approx. 10" wide x 100' long x .002" thick 321 Stainless	20250	7.30
Approx. 24" wide x 50' long x .002" thick 309 Stainless – Hi Temp	20610	9.25
Approx. 24" wide x 100' long x .002" thick 309 Stainless – Hi Temp	20710	17.75
Approx. 12" wide x 50' long x .002" thick 309 Stainless – Hi Temp	20810	4.10
Approx. 12" wide x 100' long x .002" thick 309 Stainless – Hi Temp	20910	9.25
 Approx. 12" wide x 24" long x .002" thick 321 Stainless Sheets 10/Pkg.	20315	2.30
 Approx. 12" wide x 24" long x .002" thick 321 Stainless Sheets 20/Pkg.	20320	4.00
 Approx. 12" wide x 24" long x .002" thick 321 Stainless Sheets 30/Pkg.	20325	5.70
Seam Roller Tool - Sold Separately	20215	.25



Steel Keystock



- PRECISION BRAND Keystock is used to provide driving torque between shafts and pulleys, gears, sprockets, etc.
- Material is high quality steel
- Most tolerances on dimensions are oversized to assure tight fits in keyways for positive, zero backlash power transmission
- Sizes are clearly marked on each piece

12" Square Steel Keystock

Size	Zinc Plated			Plain
	Bdl. UPC No.	Pcs. Per Bdl.	Bdl. Lb. Wgt.	Piece UPC No.
3/32	14125	10	.29	54125
1/8	14150	10	.53	54150
5/32	14175	10	.83	54175
3/16*	14200	6	.72	54200
7/32	14225	6	.98	54225
1/4*	14250	6	1.28	54250
9/32	14275	6	1.62	54275
5/16*	14300	6	2.00	54300
3/8*	14325	6	2.87	54325
7/16*	14350	4	2.60	54350
1/2*	14375	4	3.40	54375
9/16	14400	4	4.32	54400
5/8	14425	4	5.31	54425
11/16	14430	4	6.43	54430
3/4	14450	4	7.65	54450
13/16	14460	4	9.00	54470
7/8	14475	4	10.41	54475
1	14500	4	13.60	54500
1-1/8	14525	2	8.61	54525
1-3/16	14550	2	9.59	54550
1-1/4	14575	2	10.63	54575
1-3/8	14600	2	12.86	54600
1-1/2	14625	2	15.30	54625
1-5/8	14635	1	8.98	54635
1-3/4	14650	1	10.41	54650
1-7/8	14655	1	11.95	54655
2	14675	1	13.60	54675
Assortment	14680	32	12.87	-

* Assortment contains 1 bundle of each size indicated.

36" Square Steel Keystock

Size	Zinc Plated			Plain
	Bdl. UPC No.	Pcs. Per Bdl.	Bdl. Lb. Wgt.	Piece UPC No.
1/8	14700	10	1.60	54149
3/16*	14710	10	3.60	54199
1/4*	14720	10	6.40	54249
5/16	14730	10	10.00	54299
3/8*	14740	10	14.30	54324
1/2*	14750	10	25.50	54374
5/8	14760	6	23.90	54424
3/4*	14770	6	34.40	54449
7/8	14780	6	46.90	54474
1	14790	2	20.40	54499
1-3/16	14800	2	28.80	54549
1-1/4	14810	2	31.90	54574
1-3/8	14820	2	38.60	54599
1-1/2	14830	2	45.90	54624
Assortment	14999	46	84.24	-

* Assortment contains 1 bundle of each size indicated.

12" Rectangular Steel Keystock

Size	Zinc Plated			Plain
	Bdl. UPC No.	Pcs. Per Bdl.	Bdl. Lb. Wgt.	Piece UPC No.
1/8 x 3/16	15125	6	.48	55125
1/8 x 1/4	15150	6	.63	55150
1/8 x 3/8	15175	6	.95	55175
3/16 x 1/4	15200	6	.97	55200
3/16 x 5/16	15225	6	1.19	55225
3/16 x 3/8	15250	6	1.43	55250
3/16 x 1/2	15275	6	1.91	55275
1/4 x 5/16	15300	6	1.60	55300
1/4 x 3/8*	15325	6	1.91	55325
1/4 x 1/2*	15350	6	2.55	55350
5/16 x 3/8*	15375	6	2.39	55375
5/16 x 7/16	15385	6	2.79	55385
5/16 x 1/2*	15400	6	3.19	55400
5/16 x 5/8	15425	6	3.98	55425
3/8 x 7/16	15445	6	3.35	55445
3/8 x 1/2*	15450	6	3.83	55450
3/8 x 5/8	15475	6	4.78	55475
3/8 x 3/4	15500	6	5.74	55500
7/16 x 1/2	15515	6	4.50	55512
7/16 X 5/8	15510	6	5.58	55505
1/2 X 9/16	15520	6	5.74	55515
1/2 x 5/8*	15525	6	6.38	55525
1/2 x 3/4*	15550	6	7.65	55550
1/2 X 7/8	15555	6	8.93	55555
9/16 X 1	15570	6	11.48	55566
5/8 x 3/4*	15575	4	6.36	55575
5/8 X 7/8	15585	4	7.44	55585
5/8 x 1	15600	4	8.52	55600
3/4 x 7/8	15615	4	8.92	55615
3/4 x 1	15625	4	10.20	55625
3/4 X 1-1/4	15635	4	12.75	55635
7/8 x 1	15645	4	11.90	55645
7/8 x 1-1/4	15655	4	14.88	55655
1 X 1-1/4	15665	4	17.00	55665
1 X 1-1/2	15675	4	20.40	55675
Assortment	15680	16	12.50	-

* Assortment contains 2 pieces of each size indicated.

Stainless Steel Keystock



- PRECISION BRAND Stainless Steel Keystock is an excellent alternative to Steel Keystock when corrosion resistance is a concern
- Frequently used in food and marine applications
- Made from 300 series stainless steel
- Most tolerances on square dimensions are undersized

12" Rectangular Stainless Keystock

Size		Piece UPC No.	Piece Lb. Wgt.
Fraction Thickness x Width	Metric (mm)		
3/16 x 1/2	4.76 x 12.70	53501	.32
1/4 x 1/2	6.35 x 12.70	53502	.43
3/8 x 1/2	9.53 x 12.70	53503	.64
3/8 x 3/4	9.53 x 19.05	53504	.96
1/2 x 3/4	12.70 x 19.05	53505	1.28
5/8 x 3/4	15.88 x 19.05	53506	1.59
5/8 x 1	15.88 x 25.40	53507	2.13
3/4 x 1	19.05 x 25.40	53508	2.55

12" Square Stainless Steel Keystock

Size		Piece UPC No.	Piece Lb. Wgt.
Fraction	Metric (mm)		
1/8	3.18	57501	.05
3/16*	4.76	57502	.12
1/4*	6.35	57503	.21
5/16*	7.94	57504	.33
3/8*	9.53	57505	.48
7/16*	11.11	57506	.65
1/2*	12.70	57507	.85
9/16	14.29	57512	1.07
5/8	15.88	57508	1.33
3/4	19.05	57509	1.91
7/8	22.23	57510	2.60
1	25.40	57511	3.40
Assortment *		57680	11.10

* Assortment contains 4 pieces of each size indicated.

Mill Stock (Undersized Keystock)



- PRECISION BRAND Mill Stock is used in many keystock applications
- Material is high quality, low carbon steel
- For closer or undersized dimension tolerances
- Plain finish (unplated)

12" Mill Stock

Size		Bdl. UPC No.	Pcs. Per Bdl.	Bdl. Lb. Wgt.
Fraction	Metric			
1/8	3.18	56501	6	.32
3/16*	4.76	56502	6	.72
1/4*	6.35	56503	6	1.28
5/16*	7.94	56504	6	2.00
3/8*	9.53	56505	6	2.87
7/16*	11.11	56506	4	2.60
1/2*	12.70	56507	4	3.40
5/8	15.88	56508	1	1.33
3/4	19.05	56509	1	1.91
7/8	22.23	56510	1	2.60
1	25.40	56511	1	3.40
Assortment		56680	32	13.70

* Assortment contains 1 bundle of each size indicated.

Metric Keystock



- PRECISION BRAND Metric Keystock is used to accommodate metric keyways
- True metric keystock that conforms to metric keyway specifications
- Material is high quality, cold drawn steel
- Gold dichromate plating on most sizes makes product identification easy
- Sizes are clearly marked on each piece
- Special lengths also available

12" Square Gold Plated Metric Keystock

Size	Bdl. UPC No.	Pcs. Per Bdl.	Bdl. Lb. Wgt.
2mm**	04000	6	.10
3mm**	04005	6	.29
4mm*	04010	6	.51
5mm*	04015	6	.79
6mm*	04020	6	1.14
7mm	04025	6	1.55
8mm*	04030	6	2.02
10mm*	04035	4	2.11
12mm*	04040	4	3.03
14mm	04045	4	4.13
16mm	04050	4	5.39
18mm	04055	4	6.82
20mm	04060	1	2.11
22mm	04065	1	2.55
25mm**	04070	1	3.29
Assortment	04680	32	10.50

* Assortment contains 1 bundle of each size indicated.

** Only available in plain finish.

12" Rectangular Gold Plated Metric Keystock

Size Width x Thickness	Bdl. UPC No.	Pcs. Per Bdl.	Bdl. Lb. Wgt.
8mm x 5mm	05000	6	1.27
8mm x 7mm	05020	6	1.77
10mm x 6mm	05005	6	1.91
10mm x 8mm	05035	6	2.53
12mm x 6mm	05010	6	2.29
12mm x 8mm	05040	6	3.03
12mm x 10mm	05060	4	2.53
14mm x 6mm	05015	6	2.70
14mm x 9mm	05050	6	3.98
16mm x 7mm	05025	6	3.60
16mm x 10mm	05065	4	3.37
18mm x 7mm	05030	6	3.90
18mm x 11mm	05070	4	4.17
20mm x 8mm	05045	6	5.10
20mm x 12mm	05075	4	5.05
22mm x 9mm	05055	4	6.30
22mm x 14mm	05080	4	6.49
25mm x 14mm	05085	4	7.37
25mm x 22mm	05120	1	2.90
28mm x 16mm	05090	4	9.43
28mm x 25mm	05125	1	3.73
32mm x 18mm	05095	4	12.13
36mm x 20mm	05100	1	3.79
40mm x 22mm**	05105	1	4.63
45mm x 25mm**	05110	1	5.92
50mm x 28mm**	05115	1	7.37

** Only available in plain finish.



1 Meter Square Plain Metric Keystock

Size	Piece UPC No.	Pc. Lb. Wgt.
2mm	04202	.07
3mm	04207	.16
4mm	04212	.28
5mm	04217	.43
6mm	04222	.62
7mm	04227	.85
8mm	04232	1.11
10mm	04237	1.73
12mm	04242	2.49
14mm	04247	3.39
16mm	04252	4.42
18mm	04257	5.60
20mm	04262	6.91
22mm	04267	8.36
25mm	04272	10.80



1 Meter Rectangular Plain Metric Keystock

Size Width x Thickness	Piece UPC No.	Pc. Lb. Wgt.
8mm x 5mm	05202	.69
8mm x 7mm	05222	.97
10mm x 6mm	05207	1.04
10mm x 8mm	05237	1.38
12mm x 6mm	05212	1.25
12mm x 8mm	05242	1.66
12mm x 10mm	05262	2.07
14mm x 6mm	05217	1.48
14mm x 9mm	05252	2.18
16mm x 7mm	05227	1.97
16mm x 10mm	05267	2.76
18mm x 7mm	05232	2.13
18mm x 11mm	05272	3.42
20mm x 8mm	05247	2.79
20mm x 12mm	05277	4.15
22mm x 9mm	05257	3.44
22mm x 14mm	05282	5.32
25mm x 14mm	05287	6.05
25mm x 22mm	05322	9.51
28mm x 16mm	05292	7.74
28mm x 25mm	05327	12.24
32mm x 18mm	05297	9.95
36mm x 20mm	05302	12.44
40mm x 22mm	05307	15.20
45mm x 25mm	05312	19.43
50mm x 28mm	05317	24.18



12" Zinc Plated Step Keystock

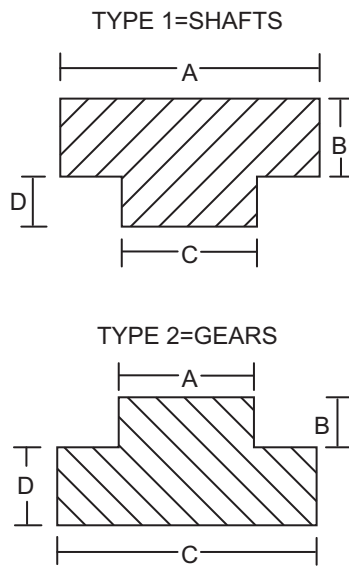

- Used in the transmission of power from a shaft to a gear, sprocket, sheave, pulley, coupling, etc.
- Often referred to as "Offset Keystock"
- Made from low carbon steel material
- Type 1 used for shafts
- Type 2 used for gears, sprockets, etc.
- Sold by individual piece

Type	Dimensions				Piece UPC No.	Piece Lb. Wgt.
	A	B	C	D		
1	3/16	3/32	1/8	1/16	15801*	.12
2	3/16	3/32	1/4	3/32	15802	.16
2	3/16	3/32	1/4	1/8	15803*	.21
2	1/4	1/8	5/16	1/8	15804*	.27
2	1/4	1/8	3/8	1/8	15805	.32
2	1/4	1/8	3/8	3/16	15806*	.40
1	3/8	3/16	5/16	1/8	15807	.40
1	3/8	3/16	5/16	5/32	15808*	.48
2	3/8	3/16	7/16	5/32	15809	.56
2	3/8	3/16	1/2	3/16	15810	.64
2	3/8	3/16	1/2	1/4	15811*	.75
1	1/2	1/4	7/16	5/32	15812	.75
2	1/2	1/4	9/16	3/16	15813	.93
2	1/2	1/4	5/8	3/16	15814	.93
2	1/2	1/4	5/8	5/16	15815*	1.20
2	1/2	1/4	11/16	1/4	15816	1.28
1	5/8	5/16	3/8	3/16	15817	1.06
2	5/8	5/16	11/16	1/4	15818	1.43
1	3/4	3/8	1/2	1/4	15819	1.60
1	3/4	3/8	5/8	3/16	15820	1.43
1	3/4	3/8	5/8	5/16	15821	1.91
1	3/4	3/8	11/16	1/4	15822	1.60
2	3/4	3/8	13/16	9/32	15823	2.25
2	3/4	3/8	7/8	7/16	15824	2.61
2	3/4	3/8	15/16	5/16	15825	2.99
2	3/4	3/8	1	1/2	15826	2.98
1	1	1/2	7/8	7/16	15827	3.40
Assortment*					15899	6.82

* Assortment contains 1 piece of each size indicated.

Hot Melt Coating



- PRECISION BRAND Hot Melt Strippable Protective Coating protects tools, gauges and metal parts from nicks, corrosion and abrasions during storage and shipping
- Packaged in convenient 5 lb. bags
- Available in two formulas: TYPE 1 and TYPE 2
- Five transparent colors: amber, clear, red, green and blue
- Poly bag packaging means easy handling and storage
- Easy to use, coating is presliced into manageable pieces
- Other colors and types available on special order
- Set time is less than 60 seconds
- To remove, coating peels right off
- Melting temperature:
TYPE 1 = 340-350°F
TYPE 2 = 320-340°F

Hot Melt Strippable Protective Coating

Color	TYPE 1 (Ethylcellulose Base)		TYPE 2 (Cellulose Acetate Butyrate Base)	
	5 lb. Bag UPC No.	30 lb. Case* (Six 5 lb. bags) UPC No.	5 lb. Bag UPC No.	30 lb. Case* (Six 5 lb. bags) UPC No.
Amber	43005	43105	43305	43405
Clear	43010	43110	43310	43410
Red	43015	43115	43315	43415
Green	43020	43120	43320	43420
Blue	43025	43125	43325	43425

* One color

Melting Pots



Actual product may vary in appearance.

- Round, cast aluminum, thermostatically controlled
- Includes cover, 6 foot 3 wire grounded cord and plug
- Temperature control ranges from 150 to 450°F
- All units are 115/120 Volt
- Other sizes available on special order

Melting Pots

Size	Watts	Inside Diameter	Inside Depth	Lb. Wgt.	UPC No.
1 pint (1/2 qt.)	400	3.5"	3"	5	43900
1 quart	600	5"	3.5"	8	43905
2 quarts	600	5.5"	5"	9	43910
4 quarts (1 gallon)*	1250	8"	5"	20	43915

* Gallon pots may be square with dimensions different than those listed above.

The First Self-Centering Punch & Die

- PRECISION BRAND TruPunch® sets make perfect, custom washers, shims and gaskets in seconds
- Eliminates time and material wasted with conventional punch & dies
- No guess work needed to center the I.D.
- No need to scribe center lines
- Exclusive, patented punch, pilot and pin system
- Packaged in a durable plastic case

See our online product demonstration at www.precisionbrand.com!

How to use the PRECISION BRAND TruPunch® sets:

1. Punch the I.D. hole first
2. Attach the appropriate I.D. pilot to the O.D. punch
3. Place the material between the top and base plates so the I.D. hole is beneath the O.D. guide hole
4. Insert the O.D. punch so that the I.D. pilot moves into the I.D. hole which will automatically center the material. Make sure the O.D. punch has been pushed completely through the top plate and is touching the material
5. Strike the punch squarely with enough force to penetrate the material with one blow



- **TruPunch®** by PRECISION BRAND can accommodate O.D. sizes up to 3/4"
- Nine punch sizes: 1/8", 3/16", 1/4", 5/16", 3/8", 7/16", 1/2", 5/8" and 3/4"
- Eight I.D. pilot sizes: 1/8", 3/16", 1/4", 5/16", 3/8", 7/16", 1/2" and 5/8"
- Cut steel, brass, copper, aluminum, rubber and plastic effortlessly up to .025" thick
- Cut stainless and blue tempered shim up to .010" thick

TruPunch® Punch & Die Set

Description	UPC No.
Complete TruPunch® Punch & Die Set	40110
Replacement Punches, Pins & Pilots (complete set only)	40115



- **"THE BIG" TruPunch™** by PRECISION BRAND can accommodate O.D. sizes up to 1-1/4"
- Four punch sizes: 7/8", 1", 1-1/8" and 1-1/4"
- Four I.D. pilot sizes: 3/4", 7/8", 1" and 1-1/8"
- Works in conjunction with PRECISION BRAND's TruPunch® #40110 (see above), I.D. pilots are interchangeable to allow for 77 O.D. and I.D. shim combinations
- Cut brass, copper, aluminum, rubber and plastic effortlessly up to .020" thick
- Cut steel up to .015" thick
- Cut stainless and blue tempered shim up to .010" thick

"The Big" TruPunch™ Punch & Die Set

Description	UPC No.
Complete "THE BIG" TruPunch™ Punch & Die Set	40200
Replacement Punches, Pins & Pilots (complete set only)	40215



- **"METRIC 10" TruPunch®** by PRECISION BRAND is the first "true metric" self-centering punch & die set
- Ten punch sizes: 3mm, 4mm, 5mm, 6mm, 7mm, 8mm, 10mm, 12mm, 16mm and 20mm
- Nine I.D. pilot sizes: 3mm, 4mm, 5mm, 6mm, 7mm, 8mm, 10mm, 12mm and 16mm
- This set is able to produce 44 different I.D. and O.D. shim combinations
- Cut steel, brass, copper, aluminum, rubber and plastic effortlessly up to .635mm thick
- Cut stainless and blue tempered shim up to .25mm thick

"METRIC 10" TruPunch® Punch & Die Set

Description	UPC No.
Complete "METRIC 10" TruPunch® Punch & Die Set	40300
Replacement Punches, Pins & Pilots (complete set only)	40315

Scan this QR Code with your Smartphone and watch our TruPunch® product demo directly from your phone!



Punch & Die Set



- Traditional style punch & die set
- Economical way to make washers, shims and gaskets
- Cut steel, brass, copper, aluminum, rubber and plastic up to .025" thick
- Cut stainless and blue tempered shim up to .010" thick
- Clear plastic top plate is marked with accurate center lines
- Nine punch sizes: 1/8", 3/16", 1/4", 5/16", 3/8", 7/16", 1/2", 5/8" and 3/4"

Punch & Die Set

Description	UPC No.
Complete Punch & Die Set	40105
Replacement Punches (complete set only)	40100

Punch & Die Stand

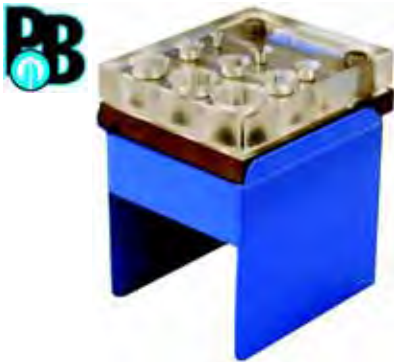

(Die sold separately)

- PRECISION BRAND Punch & Die Stand provides solid support for consistent shim and washer fabricating
- Custom fit, sturdy steel die stand holds dies from any of the Precision Brand sets: 40105, 40110, 40200 and 40300
- Stand allows for easy access to cut shims and washers
- Elevated die allows punches to fall clean, reduces shim burrs and decreases possible damage to punches
- The last hammer hit to push the punch completely through the die is eliminated, thus reducing risk of injury to the hand holding the die during this process

Punch & Die Stand

Description	UPC No.
Die Stand	40999



- PRECISION BRAND Music Wire is spring tempered and made from high carbon steel alloy
- High tensile strength and high fatigue resistance
- Applications include springs, wire forms, control linkages, armature binding, ceramic cutting and a variety of industrial uses
- Most wire is available in **cut-and-straightened** lengths and in bulk quantities as a special order.

- PRECISION BRAND Stainless Steel Wire is spring tempered, full hard, 300 series stainless steel wire
- Excellent corrosion resistant qualities and smooth finish
- Same applications as Music Wire
- All packaged wire is shrink wrapped and bar coded. .006" to .078" are packaged in easy to use pull-type dispenser boxes.

Music Wire

Stainless Steel

Diameter		Approx. Feet Per lb.	Tensile Strength (ksi) min.-max.	1 lb. UPC No.	1/4 lb. UPC No.	Tensile Strength (ksi) min.-max.	1 lb. UPC No.
Decimal	Metric (mm)						
.006	.152	10,404	415-459	21006	21206	325-355	29006
.007	.178	7,644	407-449	21007	21207	325-355	29007
.008	.203	5,853	399-441	21008	21208	325-355	29008
.009	.229	4,624	393-434	21009	21209	325-355	29009
.010	.254	3,746	387-428	21010	21210	320-350	29010
.011	.279	3,096	382-422	21011	21211	318-348	29011
.012	.305	2,601	377-417	21012	21212	316-346	29012
.013	.330	2,217	373-412	21013	21213	314-344	29013
.014	.356	1,911	369-408	21014	21214	312-342	29014
.016	.406	1,464	362-400	21016	21216	308-338	29016
.018	.457	1,156	356-393	21018	21218	304-334	29018
.020	.508	937	350-387	21020	21220	300-330	29020
.022	.559	774	345-382	21022	21222	296-326	29022
.024	.610	651	341-377	21024	21224	292-322	29024
.026	.660	555	337-373	21026	21226	291-320	29026
.029	.737	446	331-367	21029	21229	285-315	29029
.031	.787	390	328-363	21031	21231	285-315	29031
.033	.838	344	325-360	21033	21233	282-310	29033
.035	.889	306	322-357	21035	21235	280-308	29035
.037	.940	274	319-354	21037	21237	280-308	29037
.039	.991	247	316-351	21039	21239	275-304	29039
.041	1.041	223	314-348	21041	21241	275-304	29041
.043	1.092	203	311-344	21043	21243	272-300	29043
.045	1.143	185	309-342	21045	21245	272-300	29045
.047	1.194	170	307-340	21047	21247	-	-
.0475	1.207	166	-	-	-	267-295	29047
.049	1.245	156	304-337	21049	21249	-	-
.050	1.270	150	-	-	-	267-295	29050
.051	1.295	144	303-335	21051	21251	265-293	29051
.055	1.397	124	300-331	21055	21255	261-289	29055
.059	1.499	108	296-327	21059	21259	258-285	29059
.0625	1.588	97	-	-	-	258-285	29062

Sizes continued on next page.

Wire

Diameter		Approx. Feet Per lb.	Music Wire			Stainless Steel	
Decimal	Metric (mm)		Tensile Strength (ksi) min.-max.	1 lb. UPC No.	1/4 lb. UPC No.	Tensile Strength (ksi) min.-max.	1 lb. UPC No.
.063	1.600	95	293-323	21063	21263	-	-
.067	1.701	84	290-320	21067	21267	252-281	29067
.071	1.803	75	290-320	21071	21271	-	-
.072	1.829	73	-	-	-	250-278	29072
.075	1.905	67	287-317	21075	21275	-	-
.078	1.981	62	-	-	-	246-275	29078
.080	2.032	59	282-312	21080	21280	246-275	29080
.085	2.159	52	279-308	21085	21285	242-271	29085
.090	2.286	47	276-305	21090	21290	238-268	29090
.095	2.413	42	274-303	21095	21295	238-268	29095
.100	2.540	37	271-300	21100	-	232-262	29100
.105	2.667	34	-	-	-	232-262	29105
.106	2.692	33	270-299	21106	-	-	-
.109	2.769	31	-	-	-	227-257	29109
.112	2.845	30	266-294	21112	-	-	-
.118	2.997	27	266-294	21118	-	-	-
.120	3.048	26	222-253	-	-	222-263	29120
.125	3.175	24	222-253	21125	-	222-263	29125
.128	3.251	23	-	-	-	217-248	29128
.130	3.302	22	259-286	21130	-	-	-
.135	3.429	20	-	-	-	217-248	29135
.138	3.505	19	258-285	21138	-	-	-
.146	3.708	18	254-281	21146	-	-	-
.148	3.759	17	-	-	-	210-241	29148
.154	3.912	16	253-279	21154	-	-	-
.156	3.962	15	-	-	-	205-235	29156
.162	4.115	14	249-275	21162	-	205-235	29162
.170	4.318	13	249-275	21170	-	-	-
.177	4.496	12	-	-	-	198-228	29177
.180	4.572	11	245-270	21180	-	-	-
.187	4.750	10	-	-	-	194-225	29187



- Prevents glare with a uniform, deep color
- Allows scribing sharp, clear, precise lines
- Layout Fluid products cannot be shipped via air transportation
- Shelf life of one year
- Toluene free

Layout Fluid

Description	Case Qty.	Dykem® Case No.	PBP Case UPC No.
Dykem 4 oz. Brush Cap - Steel Blue	12	80300	50141
Dykem 4 oz. Brush Cap - Steel Red	12	80396	50241
Dykem 8 oz. Brush Cap - Steel Blue	12	80400	50181
Dykem 8 oz. Brush Cap - Steel Red	12	80496	50281
Dykem 16 oz. Aerosol - Steel Blue	12	80000	50162
Dykem 16 oz. Aerosol - Steel Red	12	80096	50262
Dykem 930ml Bottle - Steel Blue	12	80600	50182
Dykem 930ml Bottle - Steel Red	12	80696	50282

Layout Fluid Remover



- Prepares metal surfaces
- Does not contain toluene, chlorofluorocarbons or chlorinated solvents
- Layout Fluid Remover products cannot be shipped via air transportation
- Shelf life of one year

Layout Fluid Remover

Description	Case Qty.	Dykem® Case No.	PBP Case UPC No.
Dykem 16 oz. Aerosol Remover & Cleaner	12	82038	51160
Dykem 31 oz/930ml Non-Aerosol Remover, Cleaner & Thinner	12	82638	51175
Dykem Gallon Non-Aerosol Remover, Cleaner & Thinner*	4	82738	51150

* Only available in the U.S.

Brite-Mark® Medium Markers



- Makes permanent bright marks on metal, rubber, plastic, glass, concrete, leather, stone, wood, vinyl and more
- Valve action mechanism prevents paint in barrel from drying when cap is left off
- Drying Time: 25-35 seconds

Medium Point Paint Markers**

Description	Case Qty.	Dykem® Case No.	PBP Case UPC No.
Dykem Brite-Mark Blue	12	84001	50400
Dykem Brite-Mark Black	12	84002	50405
Dykem Brite-Mark White	12	84003	50410
Dykem Brite-Mark Yellow	12	84004	50415
Dykem Brite-Mark Orange	12	84005	50420
Dykem Brite-Mark Red	12	84006	50425
Dykem Brite-Mark Green	12	84007	50430

** Other types and colors are available on special order.

The following trademarks are owned by ITW: Dykem®, Steel Red™, Steel Blue®, Hi-Spot™, Brite-Mark®, Scrubs in a Bucket®.

Scrubs



Scrubs®

Description	Case Qty.	Dykem® Case No.	PBP Case UPC No.
Dykem Scrubs in a bucket, 72 towels per bucket	6	42272	50800

- One-step cleaning process
- Conditions and softens hands
- Works fast to loosen, dissolve and absorb dirt, grease and grime

Hi Spot



Hi Spot™

Description	Case Qty.	Dykem® Case No.	PBP Case UPC No.
Dykem Blue Hi Spot .55 oz. Tube	36	83307	50900

- Non-drying
- Shows high spots on bearings
- Transfers from one surface to another



Tool Black®



- Fast, inexpensive alternative to black oxide
- Imparts a tough, dull black protective finish to ferrous metal parts
- Ideal for prototypes, repair parts and general machine work
- The liquid solution formula is used on small immersible parts
- The Gel formula is best for larger areas or fixed vertical spaces
- One quart of TOOL BLACK® Solution covers 50 to 75 square feet, however coverage varies with application technique
- One pint of TOOL BLACK® Gel covers 20 square feet, however coverage varies with application
- Should be used at room temperature as a cold application

- PREVENT® is ozone safe
- Tool Black® products cannot be shipped via air transportation

Tool Black vs Black Oxide

Factors	Tool Black®	Hot Oxide
Set-Up Time	None	Long
Processing Time	Short	Long
Application Versatility	High	Low
Safety	High	Low
Operating Costs	Low	High
Energy Requirements	Low	High
Material Distortion	Unlikely	Likely
Control	Complete	Limited

Tool Black® Gel



Description	Case Qty.	Case UPC No.
One Complete Tool Black® Solution Kit (contains one can/bottle of each Tool Black®, Prevent® & Cleaner-Degreaser)	1 Kit	45125
Three Tool Black® Solution Kits	3 Kits	45120
One qt. Tool Black® Solution	6 Bottles	45110
16 fl. oz. Aerosol Prevent® (11 oz. net wgt.)	12 Cans	45115
One qt. Cleaner-Degreaser	12 Bottles	45105

Description	Case Qty.	Case UPC No.
One Complete Tool Black® Gel Kit (contains one bottle of each Tool Black®, Pre-Clean™ and Dri-Shield™)	1 Kit	45325
Three Tool Black® Gel Kits	3 Kits	45320
One pint Tool Black® Gel	6 Bottles	45310
One pint Pre-Clean™	6 Bottles	45305
One pint Dri-Shield™	6 Bottles	45315

ABC Blackener™



- A cosmetic blackener for most non-ferrous metals
- ABC Blackener™ works on Aluminum, Brass and Copper
- One quart of ABC Blackener™ covers 30 to 40 square feet, however coverage varies with application technique
- No special ventilating system required
- Should be used at room temperature
- May be applied by immersion or brush-on technique
- Complete kit consists of:
 - one 1-quart bottle of ABC Blackener™
 - one 1-quart bottle of ABC Sealant™
- ABC Blackener™ products cannot be shipped via air transportation

ABC Blackener™

Description	Case Qty.	Case UPC No.
One Complete ABC Blackener™ Kit (contains one quart of ABC Blackener™ and ABC Sealant™)	1 Kit	45900
Three ABC Blackener™ Kits	3 Kits	45905
One qt. ABC Blackener™	6 Bottles	45910
One qt. ABC Sealant™	6 Bottles	45915

SLIP Plate® Dry-Film Lubricant



- The original, premium dry-film, graphitic lubricant
- For use where traditional oil or grease lubricants fail or are not recommended
- Can be sprayed, rolled or brushed and bond to any clean metal, wood, concrete and most plastics
- Easy to apply, fast drying and environmentally friendly
- All SLIP Plate® products cannot be shipped via air transportation

SLIP Plate®

Description	Case Qty.	SLIP Plate® Case No.	UPC No.	Lb. Weight
SLIP Plate® Aerosol - 12 oz	12	33203	45531	13.00
SLIP Plate® Aerosol - 12 oz	6	33203G	45532	7.00
SLIP Plate® #1 - 1 quart	6	330050S	45533	17.00
SLIP Plate® #1 - 1 gallon	4	330150S	45534	41.00
SLIP Plate® #1 - 5 gallon	1	33008	45535	48.00
SLIP Plate® #3 - 1 gallon	4	33215	45536	36.00
SLIP Plate® #3 - 5 gallon	1	33208	45537	48.00
SLIP Plate® #4 - 1 gallon	4	336150S	45538	41.00
SLIP Plate® #4 - 5 gallon	1	33608	45539	48.00
SLIP Plate Penetrant Plus	6	35001G	45550	8.00
SLIP Plate® Chain & Cable	6	35201G	45551	7.00
SLIP Plate® MowerGUARD™ - 7 oz	12	34002	45570	8.00
SLIP Plate® Black Ice™ - 6 oz	12	36002	45580	8.00

SLIP Plate®, MowerGUARD™ and Black Ice™, are trademarks of Superior Graphite.

Tube-O-Lube®

NEW!



- A unique, natural form of milled graphite powder
- Designed for lubrication of: locking mechanisms, firearms, bolt and screw threads
- Popular for household and hobby uses

Tube-O-Lube®

Description	Case Qty.	Case No.	UPC No.	Lb. Wgt.
Tube-O-Lube® Graphite Powder	48	31646G	45500	2.00

Superflake™



NEW!

Superflake™ Hot Oven Chain Lubricant

- Water-based emulsion
- Creates a very durable coating
- Penetrates very tight spaces

Superflake™ Cold Oven Chain Lubricant

- Light oil-based suspension
- Creates a very durable bond
- Prolongs the life of chain and reduces noise

Superflake™

Description	Case Qty.	Superflake™ Case No.	UPC No.	Lb. Weight
Superflake™ Hot Oven Chain Lube - 1 gallon	4	37115G	45590	41.00
Superflake™ Hot Oven Chain Lube - 5 gallon	1	37108	45591	45.00
Superflake™ Cold Oven Chain Lube - 1 gallon	4	37015G	45592	41.00
Superflake™ Cold Oven Chain Lube - 5 gallon	1	37008	45593	39.20

- A unique, natural graphite that offers superior lubricity to chain pins and bushings under extreme conditions
- Superflake™ products cannot be shipped via air transportation
- Hot Oven Chain Lube is water based and prone to freezing in temperatures below 32°F

Tube-O-Lube® and Superflake™ are registered trademarks of Superior Graphite.

Steel Feeler Gage



- PRECISION BRAND Feeler Gage is made from 1/2" wide spring steel stock, close grain C1095 high carbon steel
- Material is ground and polished to precision tolerances
- Used in manufacturing, maintenance and tool & die operations wherever setting close spacing or checking extremely tight tolerances is required
- Thicknesses are clearly etched every 6" in decimal and metric
- Feeler Gage stock is packaged in 5" or 12" flat lengths, 25 feet coils and in convenient assortments
- Also available in bulk quantities
- Other sizes or thicknesses are available on special order
- True Metric Feeler Gage is available, see page 21
- Plastic, Brass and Stainless Steel Thickness Gage is also available, see pages 23 and 24

Flat Length Feeler Gage

- 5" or 12" long x 1/2" wide
- 12" lengths are individually wrapped for protection and convenience
- Ends are rounded and edges are smooth for safety
- Each piece has a 3/16" hole at one end except for .001", .040" and .050" thicknesses

Coiled Feeler Gage

- 25 feet long x 1/2" wide
- .001" to .010" coils are conveniently packaged in dispenser boxes
- Easily cut to desired length

Steel Feeler Gage

Thickness		12" Lengths	5" Lengths	25' Coils
Decimal	Metric (mm)	(12 pcs. per box) UPC No./PBP No.	(10 pcs. per box) UPC No./PBP No.	UPC No./PBP No.
.001	.025	19120/19K1	19115/19R1	19125/19H1
.0015	.038	19145/19K1X	19140/19R1X	19150/19H1X
.002	.051	19170/19K2	19165/19R2	19175/19H2
.0025	.064	19185/19K2X	–	19190/19H2X
.003	.076	19210/19K3	19205/19R3	19215/19H3
.004	.102	19235/19K4	19230/19R4	19240/19H4
.005	.127	19260/19K5	19255/19R5	19265/19H5
.006	.152	19285/19K6	19280/19R6	19290/19H6
.007	.178	19310/19K7	19305/19R7	19315/19H7
.008	.203	19335/19K8	19330/19R8	19340/19H8
.009	.229	19360/19K9	19355/19R9	19365/19H9
.010	.254	19385/19K10	19380/19R10	19390/19H10
.011	.279	19400/19K11	–	19405/19H11
.012	.305	19425/19K12	19420/19R12	19430/19H12
.013	.330	19440/19K13	–	19445/19H13
.014	.356	19465/19K14	19460/19R14	19470/19H14
.015	.381	19490/19K15	19485/19R15	19495/19H15
.016	.406	19515/19K16	19510/19R16	19520/19H16
.017	.432	19530/19K17	–	19535/19H17
.018	.457	19555/19K18	19550/19R18	19560/19H18
.019	.483	19570/19K19	–	19575/19H19
.020	.508	19595/19K20	19590/19R20	19600/19H20
.021	.533	19610/19K21	–	19615/19H21
.022	.559	19635/19K22	19630/19R22	19640/19H22
.023	.584	19650/19K23	–	19655/19H23
.024	.610	19675/19K24	19670/19R24	19680/19H24
.025	.635	19700/19K25	19695/19R25	19705/19H25
.028	.711	19715/19K28	–	19720/19H28
.030	.762	19730/19K30	–	19735/19H30
.031	.787	19745/19K31	–	19750/19H31
.032	.813	19760/19K32	–	19765/19H32
.034	.864	19775/19K34	–	19780/19H34
.040	1.016	19790/19K40	–	–
.050	1.270	19805*/19K50	–	–

* Package of 6 pieces only.



Metric Steel Feeler Gage



- PRECISION BRAND brings you “true” metric feeler gage
- Made of C1095 close grain, high carbon spring steel
- Each blade is clearly etched with thickness
- Feeler Gage stock is packaged in 127mm or 305mm flat lengths, 7.6M coils and in a convenient assortment

Flat Length Feeler Gage

- 127mm or 305mm long x 1/2" wide
- Ends are rounded and edges are smooth for safety

Coiled Feeler Gage

- 7.6M long x 1/2" wide
- Easily cut to desired length

Metric Steel Feeler Gage

Thickness (mm)	127mm Lengths (10 pcs. per pkg.) UPC No.	305mm Lengths (12 pcs. per pkg.) UPC No.	7.6M Coils UPC No.
.05	09305	09205	09105
.10	09310	09210	09110
.15	09315	09215	09115
.20	09320	09220	09120
.25	09325	09225	09125
.30	09330	09230	09130
.35	09335	09235	09135
.40	09340	09240	09140
.45	09345	09245	09145
.50	09350	09250	09150
.55	09355	09255	09155
.60	09360	09260	09160
.65	09365	09265	09165
.70	09370	09270	09170
.75	09375	09275	09175
.80	09380	09280	09180
.85	09385	09285	09185
.90	09390	09290	09190
.95	09395	09295	09195
1.00	09400	09300	09200

Steel Feeler Gage Assortments

- Contains twenty 1/2" wide blades
- Packaged in a sturdy, vinyl case
- Individual blade pockets
- Conveniently folds flat

- Each blade is clearly etched with size in metric and decimal
- Ends are rounded and edges are smooth for safety
- Vinyl case helps prevent rust and extends

blade life

- Stainless Steel, Brass and Plastic assortments also available, see pages 23 and 24.



Poc-Kit® Assortment
5" Long Blades

UPC No. 19740/PBP No. 19G20
Contains 20 Thicknesses:

.001"/.025mm	.007"/.178mm	.016"/.406mm
.0015"/.038mm	.008"/.203mm	.018"/.457mm
.002"/.051mm	.009"/.229mm	.020"/.508mm
.003"/.076mm	.010"/.254mm	.022"/.559mm
.004"/.102mm	.012"/.305mm	.024"/.610mm
.005"/.127mm	.014"/.356mm	.025"/.635mm
.006"/.152mm	.015"/.381mm	



"The Big" Poc-Kit®
Assortment 12" Long Blades

UPC No. 19990/PBP No. 19G40
Contains 20 Thicknesses:

.001"/.025mm	.007"/.178mm	.016"/.406mm
.0015"/.038mm	.008"/.203mm	.018"/.457mm
.002"/.051mm	.009"/.229mm	.020"/.508mm
.003"/.076mm	.010"/.254mm	.022"/.559mm
.004"/.102mm	.012"/.305mm	.025"/.635mm
.005"/.127mm	.014"/.356mm	.030"/.762mm
.006"/.152mm	.015"/.381mm	



Fan Blade
Assortment

UPC No. 19821

- Contains twenty-five 3" long by 1/2" wide blades
- Heavy-duty swivel holder
- Rounded ends for safety
- Sizes etched on each blade
- Packaged in poly bag
- Contents: .0015", .002", .003", .004", .005", .006", .007", .008", .009", .010", .011", .012", .013", .014", .015", .016", .018", .020", .022", .024", .025", .028", .030", .032", .035"

Metric Steel Feeler Gage Assortment



- PRECISION BRAND brings you "true" metric feeler gage in a convenient assortment
- Made of C1095 close grain, high carbon spring steel
- Assortment contains twenty 12.7mm (1/2") wide x 127mm (5") long blades
- Each blade is clearly etched with thickness
- Packaged in a sturdy vinyl case with individual blade pockets
- Assortment conveniently folds flat
- Ends are rounded and edges are smooth for safety

Metric (Steel) Poc-Kit®
Assortment

UPC No. 09740

Contains 20 Thicknesses:

.05mm	.40mm	.75mm
.10mm	.45mm	.80mm
.15mm	.50mm	.85mm
.20mm	.55mm	.90mm
.25mm	.60mm	.95mm
.30mm	.65mm	1.00mm
.35mm	.70mm	

Plastic Thickness Gage Assortments



- Contains thirteen blades riveted together for on-site convenience
- Made of the highest quality plastic material
.001" to .005" - Polyester
.0075" to .030" - Vinyl
- 1/2" wide blades are available in 5" & 12" lengths
- Color indicates thickness
- Packaged in a sturdy vinyl case
- Non-corrosive, non-conductive, non-sparking and non-marring
- Individual blades also available on special order

Plastic Thickness Gage Fan Blade Assortments

Description	UPC No.
5" Fan Blade Set	78905
12" Fan Blade Set	78900
Each assortment contains 13 Thicknesses: Decimal/Metric/Color	
.001"/.025mm/Amber	.010"/.254mm/Brown
.0015"/.038mm/Purple	.0125"/.318mm/Black
.002"/.051mm/Red	.015"/.381mm/Pink
.003"/.076mm/Green	.020"/.508mm/Yellow
.004"/.102mm/Tan	.025"/.635mm/White
.005"/.127mm/Blue	.030"/.762mm/Coral
.0075"/.191mm/Matte	

Stainless Steel Thickness Gage

- PRECISION BRAND Stainless Steel Thickness Gage is made from 1/2" wide 300 series stainless steel
- Used in manufacturing or maintenance of a technical nature where stringent, corrosion resistant and low magnetism material is needed to check extremely tight tolerances or close spacing
- Material is a good conductor and will withstand high temperatures
- Industries which use this product are aircraft, power/utility, food, automotive and marine
- .001" to .031" blades have size etched on the material; .0005" blades have size marked on blade package
- Bulk material also available
- Other thicknesses available on special order

Stainless Steel Thickness Gage

Thickness		12" Lengths UPC No.	5" Lengths UPC No.	25' Coils UPC No.
Decimal	Metric (mm)	(12 pcs. per pkg.)	(10 pcs. per pkg.)	
.0005	.013	77740	-	77105
.001	.025	77120	77115	77125
.0015	.038	77145	77140	77130
.002	.051	77170	77165	77150
.003	.076	77210	77205	77155
.004	.102	77235	77230	77175
.005	.127	77260	77255	77180
.006	.152	77285	77280	77185
.007	.178	77310	77305	77190
.008	.203	77335	77330	77195
.009	.229	77360	77355	77215
.010	.254	77385	77380	77220
.012	.305	77425	77420	77240
.015	.381	77490	77485	77245
.020	.508	77595	77590	77265
.025	.635	77770	77695	77270
.031	.787	77730	77731	77290

Stainless Steel Poc-Kit® Assortment



- PRECISION BRAND Stainless Steel Thickness Gage is made from 1/2" wide 300 series stainless steel
- Contains twenty 5" long x 1/2" wide blades
- Contains sixteen different thicknesses; duplicate blades have been included on the four most commonly used thicknesses
- Packaged in a sturdy, vinyl case which extends blade life
- Individual blade pockets
- Conveniently folds flat
- Each blade is clearly etched with size in metric and decimal
- Ends are rounded and edges are smooth for safety

Stainless Steel Poc-Kit® Assortment

UPC No. 77750	
Contains 16 Thicknesses/20 Pieces:	
2 pcs. - .001"/.025mm	.008"/.203mm
2 pcs. - .0015"/.038mm	.009"/.229mm
2 pcs. - .002"/.051mm	.010"/.254mm
2 pcs. - .003"/.076mm	.012"/.305mm
.004"/.102mm	.015"/.381mm
.005"/.127mm	.020"/.508mm
.006"/.152mm	.025"/.635mm
.007"/.178mm	.031"/.787mm

Brass Thickness Gage



- PRECISION BRAND Brass Thickness Gage is made from 1/2" wide 260 alloy
- Used in manufacturing and maintenance of highly technical markets where nonmagnetic, and non-corrosive product would be needed to check extremely close spacing
- When inserted, material should not cause a spark
- Ideal industries: computer, mining & electronics
- Blades have size etched every 6" in decimal and metric
- Bulk material also available
- Other thicknesses available on special order

Brass Thickness Gage

Thickness		12" Lengths UPC No.	5" Lengths UPC No.
Decimal	Metric (mm)	(12 pcs. per pkg.)	(10 pcs. per pkg.)
.001	.025	76120	76115
.0015	.038	76145	76140
.002	.051	76170	76165
.003	.076	76210	76205
.004	.102	76235	76230
.005	.127	76260	76255
.006	.152	76285	76280
.007	.178	76310	76305
.008	.203	76335	76330
.009	.229	76360	76355
.010	.254	76385	76380
.012	.305	76425	76420
.014	.356	76465	76460
.015	.381	76490	76485
.016	.406	76515	76510
.018	.457	76555	76550
.020	.508	76595	76590
.022	.559	76635	76630
.024	.610	76675	-
.025	.635	76700	76695
.030	.762	76730	76731
.032	.813	76760	-

Brass Poc-Kit® Assortment



- PRECISION BRAND Brass Thickness Gage is made from 1/2" wide 260 alloy
- Contains twenty 5" long x 1/2" wide blades
- Packaged in a sturdy, vinyl case which extends blade life
- Individual blade pockets
- Conveniently folds flat
- Each blade is clearly etched with size in metric and decimal
- Ends are rounded and edges are smooth for safety

Brass Poc-Kit® Assortment

UPC No. 76740

Contains 20 Thicknesses:

.001"/.025mm	.007"/.178mm	.016"/.406mm
.0015"/.038mm	.008"/.203mm	.018"/.457mm
.002"/.051mm	.009"/.229mm	.020"/.508mm
.003"/.076mm	.010"/.254mm	.022"/.559mm
.004"/.102mm	.012"/.305mm	.025"/.635mm
.005"/.127mm	.014"/.356mm	.030"/.762mm
.006"/.152mm	.015"/.381mm	



- PRECISION BRAND Steel Shim Stock is a full hard, cold rolled, low carbon 1008-1010



See inside back cover for more details.

Steel Shim Rolls

Thickness		6" x 100"		6" x 180"		12" x 120"	
Decimal	Metric (mm)	UPC No./ PBP No.	Lb. Wgt.	UPC No./ PBP No.	Lb. Wgt.	UPC No./ PBP No.	Lb. Wgt.
.001	.025	16130/16A1	.25	16700/16AJ1	.40	16140/16AA1	.87
.0015	.038	16155/16A1X	.26	16705/16AJ1X	.54	-	-
.002	.051	16195/16A2	.42	16740/16AJ2	.68	16205/16AA2	1.09
.0025	.064	16215/16A2X	.43	16745/16AJ2X	.77	-	-
.003	.076	16245/16A3	.58	16765/16AJ3	1.03	16255/16AA3	1.48
.0035	.089	16265/16A3X	.60	16770/16AJ3X	1.07	-	-
.004	.102	16280/16A4	.72	16780/16AJ4	1.31	16290/16AA4	1.90
.005	.127	16320/16A5	.96	16785/16AJ5	1.66	16330/16AA5	2.28
.006	.152	16345/16A6	1.14	16790/16AJ6	1.96	16355/16AA6	2.72
.007	.178	16370/16A7	1.31	16795/16AJ7	2.03	16380/16AA7	3.05
.008	.203	16395/16A8	1.52	16800/16AJ8	2.73	16405/16AA8	3.63
.009	.229	16415/16A9	1.66	16805/16AJ9	3.02	16425/16AA9	4.15
.010	.254	16450/16A10	1.83	16710/16AJ10	3.31	16460/16AA10	4.64
.012	.305	16480/16A12	2.24	16715/16AJ12	4.07	16490/16AA12	5.35
.0135	.343	16500/16A13X	2.30	16720/16AJ13X	4.13	-	-
.015	.381	16530/16A15	2.76	16725/16AJ15	5.03	16540/16AA15	6.69
.0165	.419	16550/16A16X	3.19	16730/16AJ16X	5.05	-	-
.018	.457	16560/16A18	3.63	16735/16AJ18	5.51	16570/16AA18	8.58
.020	.508	16590/16A20	3.85	16750/16AJ20	6.54	16600/16AA20	9.28
.022	.559	16610/16A22	3.94	16755/16AJ22	7.17	-	-
.025	.635	16630/16A25	5.04	16760/16AJ25	8.41	16640/16AA25	11.25
.031	.787	16660/16A31	6.58	16775/16AJ31	10.33	16670/16AA31	13.58

Steel Metric Shim Rolls

150mm x 2.5m		
Millimeter Thickness	UPC No.	Lb. Wgt.
.05	16971	.42
.10	16972	.72
.15	16973	1.14
.20	16974	1.52
.25	16975	1.83
.30	16976	2.24
.40	16977	2.76
.50	16978	3.85
.65	16979	5.04
.80	16980	6.58

Steel Metric Sheet Assortment

Contents	150mm x 300mm	
	UPC No.	Lb. Wgt.
10 Sheets Per Package (Includes one sheet of each: .05mm, .10mm, .15mm, .20mm, .25mm, .30mm, .40mm, .50mm, .65mm & .80mm)	16999	2.90

Steel Shim Roll Assortment

Contents	6" x 50"	
	UPC No./ PBP No.	Lb. Wgt.
4 Rolls Per Package (Includes one roll of each: .001", .002", .003" & .005")	16690/16B4	.94

Steel Shim Stock Sheets



- PRECISION BRAND Steel Shim Stock is a full hard, cold rolled, low carbon 1008-1010



See inside back cover for more details.

Steel Shim
Rolls

Steel Shim Sheets*



Thickness		6" x 18" 10 Sheets Per Pkg.		6" x 25" 2 Sheets Per Pkg.		8" x 12" 5 Sheets Per Pkg.	
Decimal	Metric (mm)	UPC No./ PBP No.	Lb. Wgt.	UPC No./ PBP No.	Lb. Wgt.	UPC No./ PBP No.	Lb. Wgt.
.001	.025	16810/16AN1	.63			16920	.34
.0015	.038	16815/16AN1X	.75				
.002	.051	16820/16AN2	.99			16925	.47
.0025	.064	16825/16AN2X	1.18				
.003	.076	16830/16AN3	1.25			16930	.61
.0035	.089	16835/16AN3X	1.37	Available			
.004	.102	16840/16AN4	1.50	as a		16935	.74
.005	.127	16845/16AN5	1.63	special		16940	.88
.006	.152	16850/16AN6	2.13	order			
.007	.178	16855/16AN7	2.45			16945	1.15
.008	.203	16860/16AN8	2.75				
.009	.229	16865/16AN9	2.99				
.010	.254	16870/16AN10	3.38			16947	1.56
.012	.305	16875/16AN12	3.93	16475/16AY12	1.45	16948	1.83
.0135	.343	16880/16AN13X	4.13	-	-		
.015	.381	16885/16AN15	4.93	16525/16AY15	1.73	16949	2.24
.0165	.419	16890/16AN16X	5.05	-	-		
.018	.457	16895/16AN18	5.93	-	-		
.020	.508	16900/16AN20	6.50	16585/16AY20	2.15	16952	2.91
.022	.559	16905/16AN22	6.73	-	-		
.025	.635	16910/16AN25	8.00	16625/16AY25	2.58		
.031	.787	16915/16AN31	9.93	16655/16AY31	3.09		

* Other dimensions available as a special order.

Steel Shim Sheet Assortments



Contents	6" x 12"		6" x 18"		8" x 12"		12" x 24"	
	UPC No./ PBP No.	Lb. Wgt.	UPC No./ PBP No.	Lb. Wgt.	UPC No.	Lb. Wgt.	UPC No./ PBP No.	Lb. Wgt.
12 Sheets Per Package (Includes one sheet of each: .001", .0015", .002", .003", .004", .005", .006", .007", .008", .010", .012" & .015")	16680/16AF12	1.74	16950/16AZ12	2.28	-	-	-	-
15 Sheets Per Package (Includes one sheet of each: .001", .0015", .002", .003", .004", .005", .006", .007", .008", .010", .012", .015", .020", .025" & .031")	16685/16AF15	3.29	16955/16AZ15	4.61	-	-	-	-
9 Sheets Per Package (Includes one sheet of each: .002", .003", .004", .005", .007", .010", .012", .015" & .020")	-	-	-	-	16953	2.32	-	-
14 Sheets Per Package (Includes one sheet of each: .001", .002", .003", .004", .005", .006", .007", .008", .010", .012", .015", .020", .025" & .031")	-	-	-	-	-	-	16965/16AAZ14	12.30

Brass Shim Stock



- PRECISION BRAND Brass Shim Stock is a half hard, cold rolled, 260 alloy



See inside back cover for more details.

Brass Shim Roll Assortment

Contents	6" x 50"	
	UPC No./ PBP No.	Lb. Wgt.
4 Rolls Per Package (Includes one roll of each: .001", .002", .003" & .005")	17560/17T4	1.36

Brass Shim Rolls

Brass Shim Sheets*

Thickness	6" x 60"				6" x 100"				6" x 180"				12" x 120"				6" x 18"		6" x 25"	
	Deci- mal	Metric (mm)	UPC No./ PBP No.	Lb. Wgt.	UPC No./ PBP No.	Lb. Wgt.	UPC No./ PBP No.	Lb. Wgt.	UPC No./ PBP No.	Lb. Wgt.	UPC No./ PBP No.	Lb. Wgt.	UPC No./ PBP No.	Lb. Wgt.	UPC No./ PBP No.	Lb. Wgt.	UPC No./ PBP No.	Lb. Wgt.		
.001	.025	17605/17SX1	.11	17135/17S1	.29	17700/17SJ1	.45	17145/17SS1	.90	17810/17SN1	.63			17810/17SN1	.63					
.0015	.038	17610/17SX1X	.14	17160/17S1X	.38	17705/17SJ1X	.58	-	-	17815/17SN1X	.78			17815/17SN1X	.78					
.002	.051	17615/17SX2	.22	17195/17S2	.46	17725/17SJ2	.75	17205/17SS2	1.18	17820/17SN2	1.13			17820/17SN2	1.13					
.003	.076	17620/17SX3	.33	17240/17S3	.64	17740/17SJ3	1.13	17250/17SS3	1.56	17830/17SN3	1.23			17830/17SN3	1.23			Available		
.004	.102	17625/17SX4	.44	17265/17S4	.82	17750/17SJ4	1.42	17275/17SS4	2.05	17840/17SN4	1.94			17840/17SN4	1.94			as a		
.005	.127	17630/17SX5	.55	17305/17S5	1.03	17755/17SJ5	1.77	17315/17SS5	2.46	17845/17SN5	2.00			17845/17SN5	2.00			special		
.006	.152	17635/17SX6	.66	17330/17S6	1.21	17760/17SJ6	2.09	17340/17SS6	2.90	17850/17SN6	2.25			17850/17SN6	2.25			order		
.007	.178	17640/17SX7	.77	17355/17S7	1.45	17765/17SJ7	2.52	-	-	17855/17SN7	2.63			17855/17SN7	2.63					
.008	.203	17645/17SX8	.88	17370/17S8	1.57	17770/17SJ8	2.89	17380/17SS8	3.93	17860/17SN8	2.91			17860/17SN8	2.91					
.009	.229	17650/17SX9	.99	17390/17S9	1.78	17775/17SJ9	3.25	-	-	17865/17SN9	2.98			17865/17SN9	2.98					
.010	.254	17655/17SX10	1.10	17415/17S10	1.96	17710/17SJ10	3.31	17425/17SS10	4.85	17870/17SN10	3.63			17870/17SN10	3.63					
.012	.305	17660/17SX12	1.32	17445/17S12	2.44	17715/17SJ12	3.97	17426/17SS12	5.80	17875/17SN12	4.25			17875/17SN12	4.25	17440/17SY12	1.54			
.015	.381	17665/17SX15	1.65	17475/17S15	3.08	17720/17SJ15	5.50	17427/17SS15	7.08	17885/17SN15	5.44			17885/17SN15	5.44	17470/17SY15	1.84			
.018	.457	-	-	17477/17S18	3.60	-	-	-	-	-	-			-	-	-	-			
.020	.508	17670/17SX20	2.20	17495/17S20	3.67	17730/17SJ20	7.14	17428/17SS20	9.83	17900/17SN20	7.00			17900/17SN20	7.00	17490/17SY20	2.26			
.025	.635	17675/17SX25	2.75	17515/17S25	5.08	17735/17SJ25	8.81	-	-	17910/17SN25	8.69			17910/17SN25	8.69	17510/17SY25	2.75			
.031	.787	17680/17SX31	3.42	17535/17S31	6.13	17745/17SJ31	10.74	-	-	17915/17SN31	10.63			17915/17SN31	10.63	17530/17SY31	3.26			

* Other dimensions available as a special order.

Brass Shim Sheet Assortments

Brass Metric Shim Rolls

Contents	6" x 12"		6" x 18"		150mm x 300mm		150 millimeters x 2.5 meters		
	UPC No./ PBP No.	Lb. Wgt.	UPC No./ PBP No.	Lb. Wgt.	UPC No.	Lb. Wgt.	Millimeter Thickness	UPC No.	Lb. Wgt.
12 Sheets Per Package (Includes one sheet of each: .001", .0015", .002", .003", .004", .005", .006", .007", .008", .010", .012" & .015")	17545/17SF12	1.86	17950/17SZ12	2.76	-	-	.05	17971	.46
15 Sheets Per Package (Includes one sheet of each: .001", .0015", .002", .003", .004", .005", .006", .007", .008", .010", .012", .015", .020", .025" & .031")	17550/17SF15	3.32	17955/17SZ15	5.31	-	-	.10	17972	.82
10 Sheets Per Package (Includes one sheet of each: .05mm, .10mm, .15mm, .20mm, .25mm, .30mm, .40mm, .50mm, .65mm & .80mm)	-	-	-	-	17999	3.14	.15	17973	1.21
							.20	17974	1.57
							.25	17975	1.96
							.30	17976	2.44
							.40	17977	3.08
							.50	17978	3.67
							.65	17979	5.08
							.80	17980	6.13

Stainless Steel Shim Stock



- PRECISION BRAND Stainless Steel Shim Stock is a full hard, cold rolled, 300 series stainless steel



See inside back cover for more details.

Stainless Steel Shim Rolls

Thickness		6" x 50"		6" x 60"		12" x 50"	
Decimal	Metric (mm)	UPC No./ PBP No.	Lb. Wgt.	UPC No./ PBP No.	Lb. Wgt.	UPC No./ PBP No.	Lb. Wgt.
*.0005	.013	22110/22LX	.17	22138/22LXX	.21	-	-
.001	.025	22125/22L1	.21	22139/22LX1	.23	22135/22LL1	.60
.0015	.038	22126/22L1X	.23	22141/22LX1X	.26	-	-
.002	.051	22150/22L2	.25	22146/22LX2	.30	22160/22LL2	.62
.003	.076	22175/22L3	.34	22149/22LX3	.41	22185/22LL3	.78
.004	.102	22195/22L4	.43	22152/22LX4	.55	22205/22LL4	.95
.005	.127	22220/22L5	.56	22153/22LX5	.66	22230/22LL5	1.11
.006	.152	22240/22L6	.63	22154/22LX6	.74	22250/22LL6	1.26
.007	.178	22260/22L7	.73	22156/22LX7	.85	22270/22LL7	1.46
.008	.203	22285/22L8	.80	22157/22LX8	.95	22295/22LL8	1.78
.009	.229	22305/22L9	.90	22158/22LX9	1.07	-	-
.010	.254	22320/22L10	.98	22142/22LX10	1.15	22330/22LL10	2.14
.012	.305	22340/22L12	1.24	22143/22LX12	1.44	22350/22LL12	2.46
.015	.381	22365/22L15	1.53	22144/22LX15	1.71	22375/22LL15	3.01
.020	.508	22390/22L20	2.20	22147/22LX20	2.16	22400/22LL20	4.45
.025	.635	22410/22L25	2.74	22148/22LX25	3.03	-	-
.031	.787	22430/22L31	3.18	22151/22LX31	3.59	-	-

* Not branded

Stainless Metric Shim Rolls

150 millimeters x 1.25 meters

Millimeter Thickness	UPC No.	Lb. Wgt.
.05	22971	.25
.10	22972	.43
.15	22973	.63
.20	22974	.80
.25	22975	.98
.30	22976	1.24
.40	22977	1.53
.50	22978	2.20
.65	22979	2.74
.80	22980	3.18

6" Wide Stainless Sheets

Thickness		6" x 25" 2 Sheets Per Pkg.	
Decimal	Metric (mm)	UPC No./ PBP No.	Lb. Wgt.
.008	.203	22520/22LY8	1.11
.010	.254	22550/22LY10	1.31
.012	.305	22560/22LY12	1.58
.015	.381	22570/22LY15	1.68
.020	.508	22580/22LY20	2.20
.025	.635	22590/22LY25	2.68
.031	.787	22600/22LY31	3.18

12" Wide Stainless Sheets

Thickness		12" x 24" 2 Sheets Per Pkg.	
Decimal	Metric (mm)	UPC No.	Lb. Wgt.
-	-	-	-
-	-	-	-
-	-	-	-
-	-	-	-
.025	.635	22992	4.93
.031	.787	22993	5.92

Stainless Steel Assortments

Contents	6" x 12"		Contents	150 mm x 300 mm	
	UPC No./ PBP No.	Lb. Wgt.		UPC No.	Lb. Wgt.
8 Sheets Per Package (Includes one sheet of each: .001", .002", .003", .005", .008", .010", .015" & .020")	22445/22LF8	1.54	8 Sheets Per Package (Includes one sheet of each: .05mm, .10mm, .15mm, .20mm, .25mm, .30mm, .40mm & .50mm)	22999	1.70

Blue Tempered Shim Stock

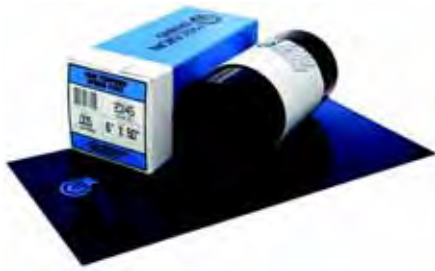

- PRECISION BRAND Blue Tempered Shim Stock is a high carbon 1095 hardened and tempered spring steel



See inside back cover for more details.

50" Blue Tempered Shim Rolls

Thickness		Width	UPC No./ PBP No.	Lb. Wgt.
Decimal	Metric (mm)			
.002	.051	3"	23110/23C2	.18
.003	.076	3"	23120/23C3	.22
.004	.102	5"	23130/23C4	.40
.005	.127	6"	23145/23C5	.54
.006	.152	6"	23155/23C6	.63
.007	.178	6"	23165/23C7	.74

Blue Tempered Assortment

Contents	6" x 12"	
	UPC No./ PBP No.	Lb. Wgt.
6 Sheets Per Package (Includes one sheet of each: .005", .010", .015", .020", .025" & .032")	23290/ 23CR6	2.40

Blue Tempered Sheets

Thickness		6" x 25" 2 Sheets Per Pkg.	
Decimal	Metric (mm)	UPC No./ PBP No.	Lb. Wgt.
.008	.203	23170/23CY8	1.10
.010	.254	23180/23CY10	1.30
.012	.305	23200/23CY12	1.50
.015	.381	23220/23CY15	1.70
.020	.508	23240/23CY20	2.10
.025	.635	23260/23CY25	2.60
.032	.813	23280/23CY32	3.20



Blue Tempered Metric Shim Rolls 1.25m Long

Thickness	Width	UPC No.	Lb. Wgt.
.05mm	76mm	23971	.18
.10mm	127mm	23972	.40
.15mm	150mm	23973	.63

Aluminum Shim Stock



- PRECISION BRAND Aluminum Shim Stock is made from 1100 Series (H-18) or 1145 Series (H-19) full hard, tempered aluminum

6" x 100" Aluminum Shim

Thickness		UPC No.	Lb. Wgt.
Decimal	Metric (mm)		
.001	.025	69130	.18
.002	.051	69195	.24
.003	.076	69245	.30
.004	.102	69280	.36
.005	.127	69320	.47
.006	.152	69345	.53
.008	.203	69395	.65
.010	.254	69450	.77

Copper Shim Stock



- PRECISION BRAND Copper Shim Stock is made from 110 annealed copper

6" x 100" Copper Shim

Thickness		UPC No.	Lb. Wgt.
Decimal	Metric (mm)		
.001	.025	68130	.31
.002	.051	68195	.50
.003	.076	68245	.68
.004	.102	68280	.86
.005	.127	68320	1.05
.006	.152	68345	1.23
.007	.178	68370	1.42
.008	.203	68395	1.60
.010	.254	68450	1.97

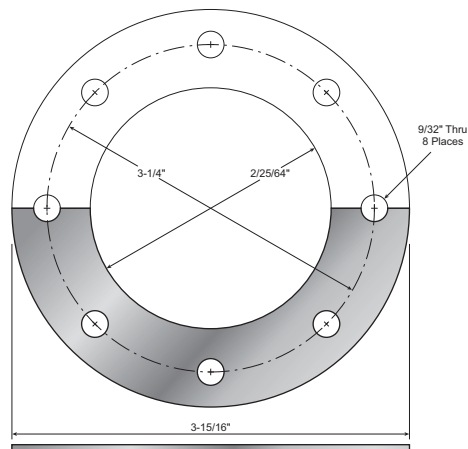
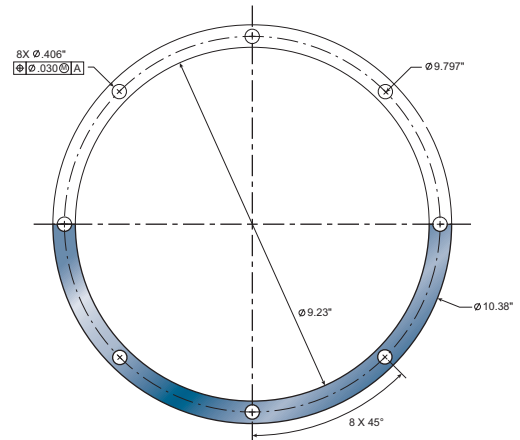
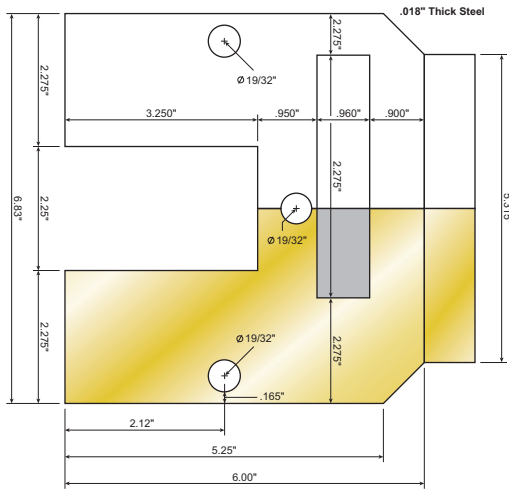

From print to part... Precision Brand Products, Inc. can do it!

Precision Brand Products, Inc. is a leading producer of custom shims. We have the resources and technology to fabricate shims for the most exacting and intricate applications. Our extensive inventories of "in-stock" raw materials — that exceed industry thickness tolerances — ensure a fast, economical turnaround. Our meticulous attention to quality guarantees that the specifications, chemistry, and hardness of your shim will be accurate.

When speed and accuracy count...count on Precision Brand Products, Inc.

Just contact us with your information!

On the web at: www.precisionbrand.com
 Email: pbpcustomshims@pbrand.com
 Fax: 1 630 969 0310
 Phone: 1 630 969 7200

Color Coded Shim (Plastic Material)

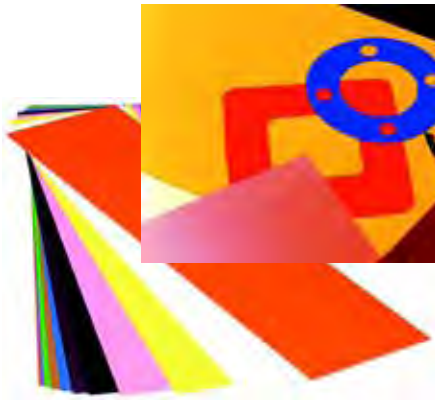

- PRECISION BRAND Color Coded Shim is made from a high quality plastic material
- Eliminates need for micrometer, saves time and reduces error
- Used for gaskets, special parts and various manufacturing applications
- Easy to cut
- Resists oil
- Minimal compression during use
- Non-conductive to electricity
- Thickness indicated by shim color
- For pre-cut Plastic Slotted Shim used in light duty alignments, see page 35
- For Plastic Arbor Shims, see page 41

Color Coded Shim Flat Sheets

Thickness		Color	Material	5" x 20" UPC No.	10" x 20" UPC No.	20" x 20" UPC No.	25" x 50" UPC No.
Decimal	Metric (mm)						
.0005	.013	Silver	Polyester	44105	44205	44305	44405
.001	.025	Amber	Polyester	44110	44210	44310	44410
.0015	.038	Purple	Polyester	44115	44215	44315	44415
.002	.051	Red	Polyester	44120	44220	44320	44420
.003	.076	Green	Polyester	44125	44225	44325	44425
.004	.102	Tan	Polyester	44130	44230	44330	44430
.005	.127	Blue	Polyester	44135	44235	44335	44435
.0075	.191	Matte	Vinyl	44140	44240	44340	44440
.010	.254	Brown	Vinyl	44145	44245	44345	44445
.0125	.318	Black	Vinyl	44150	44250	44350	44450
.015	.381	Pink	Vinyl	44155	44255	44355	44455
.020	.508	Yellow	Vinyl	44160	44260	44360	44460
.025	.635	White	Vinyl	44165	44265	44365	44465
.030	.762	Coral	Vinyl	44170	44270	44370	44470
.040	1.016	Clear	Vinyl	44175	44275	44375	44475*
.050	1.270	Clear	Vinyl	44180	44280	44380	44480*
.060	1.524	Clear	Vinyl	44185	44285	44385	44485*

Color Coded Shim Precision Pak®

Thickness		Pkg. Qty.	5" x 20" UPC No.	10" x 20" UPC No.
Decimal	Metric (mm)			
.0005	.013	5 ea.	44505	44605
.001	.025	5 ea.	44510	44610
.0015	.038	5 ea.	44515	44615
.002	.051	5 ea.	44520	44620
.003	.076	5 ea.	44525	44625
.004	.102	10 ea.	44530	44630
.005	.127	10 ea.	44535	44635
.0075	.191	10 ea.	44540	44640
.010	.254	10 ea.	44545	44645
.0125	.318	10 ea.	44550	44650
.015	.381	10 ea.	44555	44655
.020	.508	10 ea.	44560	44660
.025	.635	10 ea.	44565	44665
.030	.762	10 ea.	44570	44670
.040	1.016	3 ea.	44575	44675
.050	1.270	3 ea.	44580	44680
.060	1.524	3 ea.	44585	44685

* .040 to .060 are 21" x 51" sheets.

Color Coded Shim Assortments

5" x 20" UPC No. 44905	10" x 20" UPC No. 44910	20" x 20" UPC No. 44915
------------------------------	-------------------------------	-------------------------------

Each assortment contains 1 each of the following thicknesses: .0005", .001", .0015", .002", .003", .004", .005", .0075", .010", .0125", .015", .020", .025" & .030".

CONDITIONS: Determination of the suitability of the material to the use contemplated is the user's responsibility. Users assume all risk resulting from the use of these products and must confirm adaptability thereof by their own tests.

Color Coded Shim Typical Properties

Decimal Thickness	.0005 - .005	.0075 - .030	.040 - .060
Tensile Strength, p.s.i.	30,000	6,600	14,000
Ultimate Elongation	90%	180%	180%
Folding Endurance (MIT)	>100,000	37,000	37,000
Tear Strength (Elmendorf)	20 g/mil	-	-
Moisture Absorption	.08%	.15%	.15%
Thickness Tolerance	+/-5%	+/-5%	+/-5%
Military Specification	LP-377	LP-535	LP-535
Compression at 5,000 p.s.i.	1.0%	.7%	.7%
Service Temperature	-90°F to 300°F	-10°F to 155°F	-10°F to 155°F

* Contact factory for further product information.

Slotted Shim 300 Series Stainless Steel



Decimal Slotted Shim Slot Sizes

Size A 2" x 2"	Size B 3" x 3"	Size C 4" x 4"	Size D 5" x 5"	Size E 6" x 6"	Size H 8" x 8"
5/8"	7/8"	1-1/4"	1-5/8"	2"	2-3/8"

THE NEW SHAPE IN PRODUCTIVITY

- PRECISION BRAND Slotted Shim is the best way to solve alignment and leveling problems on motors, pumps, generators and other plant machinery
- These shims are economical, safe and accurate
- Available in six sizes to cover most applications
- Full line kits and replacement sizes are available
- 300 series stainless steel resists rust and corrosion
- Each shim marked with thickness in decimal and/or metric
- Shim thickness tolerances meet or exceed industry standards
- Shims conform to standard bolt and stud sizes
- 6" & 8" sizes are a new way to level large, heavy-duty motors, pumps and equipment
- 6" & 8" sizes are available in thicknesses from .001" to .500"

Decimal Slotted Shim Assortment Kits

Kit Type	Size A 2" x 2"		Size B 3" x 3"		Size C 4" x 4"		Size D 5" x 5"		Kit Type	Size E 6" x 6"		Size H 8" x 8"	
	UPC No.	Lb. Wgt.	UPC No.	Lb. Wgt.	UPC No.	Lb. Wgt.	UPC No.	Lb. Wgt.		UPC No.	Lb. Wgt.	UPC No.	Lb. Wgt.
FULL ASSORTMENT ¹	42900	10.9	42910	24.4	42920	41.1	42930	61.7	REGULAR ASSORTMENT ⁴	42925	23.5	42935	40.0
MINI ASSORTMENT ²	42940	6.8	42950	14.6	42960	24.2	42970	35.5					
SHOP KIT ³	42945	3.7	42955	4.4	42965	6.6	42975	9.9					
METAL BOX ONLY	42901	2.3	42911	4.2	42921	6.3	42931	7.8	METAL BOX ONLY	42961	4.9	42981	8.1

- Full Assortment – Each Full Assortment contains 20 pieces of the following sizes: .001", .002", .003", .004", .005", .010", .015", .020", .025", .050", .075", .100" & .125". A Full Assortment Kit contains 260 pieces and is packaged in a durable metal box.
- Mini Assortment – Each Mini Assortment contains 10 pieces of the following sizes: .001", .002", .003", .004", .005", .010", .015", .020", .025", .050", .075", .100" & .125". A Mini Assortment Kit contains 130 pieces and is packaged in a durable metal box.
- Shop Kit – Each Shop Kit contains 10 pieces of the following sizes: .001", .003", .005", .010", .015", .020", .025" & .075". A Shop Kit contains 80 pieces and is packaged in a sturdy chipboard box.
- Regular Assortment – Each Regular Assortment contains 4 pieces of the following sizes: .001", .002", .003", .004", .005", .010", .015", .020", .025", .050", .075", .100" & .125". A Regular Assortment Kit contains 52 pieces and is packaged in a durable metal box.

Decimal Slotted Shim Refill Packages

Decimal Thickness	Pcs. Per Pkg.	Size A – 2" x 2"		Size B – 3" x 3"		Size C – 4" x 4"		Size D – 5" x 5"		Pcs. Per Pkg.	Size E – 6" x 6"		Size H – 8" x 8"	
		UPC No.	Lb. Wgt.	UPC No.	Lb. Wgt.	UPC No.	Lb. Wgt.	UPC No.	Lb. Wgt.		UPC No.	Lb. Wgt.	UPC No.	Lb. Wgt.
.001	20	42205	.03	42305	.07	42405	.11	42505	.17	5	42605	.15	42805	.22
.002	20	42210	.05	42310	.12	42410	.19	42510	.30	5	42610	.20	42810	.32
.003	20	42215	.07	42315	.15	42415	.27	42515	.43	5	42615	.25	42815	.37
.004	20	42220	.09	42320	.21	42420	.35	42520	.54	5	42620	.30	42820	.47
.005	20	42225	.11	42325	.25	42425	.43	42525	.65	5	42625	.35	42825	.57
.010	20	42230	.21	42330	.48	42430	.81	42530	1.28	5	42630	.65	42830	1.02
.015	10	42235	.16	42335	.38	42435	.65	42535	.99	5	42635	.90	42835	1.47
.020	10	42240	.22	42340	.49	42440	.85	42540	1.30	5	42640	1.15	42840	1.92
.025	10	42245	.27	42345	.61	42445	1.05	42545	1.61	5	42645	1.40	42845	2.37
.050	5	42250	.27	42350	.61	42450	1.03	42550	1.66	5	42650	2.75	42850	4.62
.075	5	42255	.39	42355	.90	42455	1.53	42555	2.36	5	42655	4.05	42855	6.87
.100	5	42260	.51	42360	1.22	42460	2.07	42560	3.14	5	42660	5.80	42860	9.92
.125	5	42265	.63	42365	1.45	42465	2.48	42565	3.82	5	42665	6.45	42865	11.02
.250		*		*		*		*		1	42670	2.65	42870	4.49
.500		*		*		*		*		1	42675	5.20	42875	8.86

* Available on special order.

Slotted Shim 300 Series Stainless Steel

All-In-One Decimal Slotted Shim Assortment Kit



Kit Description	UPC No.	Lb. Wgt.
Each Assortment contains 5 pcs. of each .001", .002", .003", .004", .005", .010", .015", .020", .025", .050", .075", .100" and .125" in all four shim sizes; A - 2" x 2", B - 3" x 3", C - 4" x 4", and D - 5" x 5". It also contains 5 pieces of each .020" and .045" thick Sof' Shoe® shims in all four sizes; A - 2" x 2", B - 3" x 3", C - 4" x 4" and D - 5" x 5". Assortment contains 300 pieces and is packaged in a durable metal box.	42996	45.00

Sof' Shoe® Shim



Scan this QR Code with your Smartphone and watch our Sof' Shoe® product demo directly from your phone!



- PRECISION BRAND Sof' Shoe® shim solves angular soft foot alignment problems on motors, pumps, generators, turbines and other plant machinery in minutes
- Sof' Shoe® shim cures angular soft foot and extends bearing and motor life
- Sof' Shoe® shim is made of a proprietary elastomer which has unique flow and set characteristics to fill irregular gaps
- Sof' Shoe® shim is an inexpensive alternative when compared to more time consuming and expensive options such as milling the base or foot, hand cutting graduated shims, replacing base or rebuilding base with poured epoxy
- Each Sof' Shoe® shim thickness has a 12 percent flat compression under standard bolt torque, yet will absorb the angularity of nearly half its thickness
- Sof' Shoe® shim is stable to 225°F
- Flat sheets are also available on special order
- For more technical information on PRECISION BRAND Sof' Shoe® shim and angular soft foot contact the PRECISION BRAND factory
- Also available in bulk in approximately 39" nominal widths



Sof' Shoe® Shim Slot Sizes

Size A 2" x 2"	Size B 3" x 3"	Size C 4" x 4"	Size D 5" x 5"
5/8"	7/8"	1-1/4"	1-5/8"

Sof' Shoe® Slotted Shim

Decimal Thickness	Color	Pcs. Per Pkg.	Size A 2" x 2"	Size B 3" x 3"	Size C 4" x 4"	Size D 5" x 5"
			UPC No.	UPC No.	UPC No.	UPC No.
.020	Blue	10	49105	49110	49115	49120
.045	Yellow	10	49125	49130	49135	49140

Wedgies™ Installation Shims



- Wedgies™ Installation Shims are stackable, non-slip, plastic shims used for leveling and stabilizing
- Plastic material means Wedgies™ Shims will not shrink, swell or rot

Soft/Flexible Wedgies™ Shims

- Made from vinyl
- Super flexible, absorb vibration, reduce noise, great stabilizing cushion
- Trim easily with one knife stroke
- Also available in mini (1.12" x .58" x .16") and large (3.54" x 2.36" x .48" DOUBLE WIDE) sizes

Hard/Rigid Wedgies™ Shims

- Made from polypropylene
- Tough and durable, can hold up to 2,000 pounds
- Glue resistant, useful as a clamping pad on angled surface
- Also available in mini (1.12" x .58" x .16") and large (3.54" x 2.36" x .48" DOUBLE WIDE) sizes

Wedgies™ Shims

Type	Color	Pkg. Size	UPC No.	Lb. Weight
Rigid	Black	200	48605	2.00
Rigid	Black	30	48620	.40
Flexible	White	200	48805	2.63
Flexible	White	30	48820	.48
Rigid (mini)	Translucent	100	48930	.231
Flexible (mini)	Clear	100	48935	.298
Rigid (large)	Translucent	8	48940	.330
Flexible (large)	Clear	8	48945	.459
Assortment	Various	37	48950	.532

Each assortment contains 8 Rigid Mini-Shims, 8 Flexible Mini-Shims, 4 Rigid Large Shims, 2 Flexible Large Shims, 5 Flexible Standard Shims and 10 Rigid Standard Shims

Metric Slotted Shim 300 Series Stainless Steel



Metric Slotted Shim Slot Sizes

50mm X 50mm	75mm X 75mm	100mm X 100mm	125mm X 125mm
16mm	22mm	32mm	41mm

Metric Slotted Shim Refill Packages

Millimeter Thickness	Pcs. Per Pkg.	50mm x 50mm		75mm x 75mm		100mm x 100mm		125mm x 125mm	
		UPC No.	Lb. Wgt.	UPC No.	Lb. Wgt.	UPC No.	Lb. Wgt.	UPC No.	Lb. Wgt.
.025	10	81205	.06	81305	.09	81405	.13	81505	.17
.050	10	81210	.07	81310	.12	81410	.17	81510	.24
.100	10	81215	.09	81315	.17	81415	.25	81515	.36
.200	10	81220	.13	81320	.26	81420	.41	81520	.61
.250	10	81225	.16	81325	.31	81425	.49	81525	.74
.400	10	81230	.21	81330	.43	81430	.69	81530	1.05
.500	10	81235	.26	81335	.55	81435	.89	81535	1.37
.700	10	81240	.34	81340	.74	81440	1.21	81540	1.87
1.000	10	81245	.47	81345	1.02	81445	1.69	81545	2.63
2.000	10	81250	.87	81350	1.93	81450	3.24	81550	5.06

Metric Slotted Shim Assortment Kits

Kit Type	50mm x 50mm		75mm x 75mm		100mm x 100mm		125mm x 125mm	
	UPC No.	Lb. Wgt.	UPC No.	Lb. Wgt.	UPC No.	Lb. Wgt.	UPC No.	Lb. Wgt.
SHOP KIT Each Shop Kit contains 10 pieces of the following sizes: .025mm, .05mm, .1mm, .2mm, .25mm, .4mm, .5mm, .7mm, 1mm & 2mm. A Shop Kit contains 100 pieces and is packaged in a sturdy chipboard box.	81945	2.66	81955	5.61	81965	9.17	81975	14.10
METAL BOX ONLY	42901	2.30	42911	4.20	42921	6.30	42931	7.80

Plastic Slotted Shim



- PRECISION BRAND Plastic Slotted Shim is used for mounting and leveling smaller fractional horsepower motors, various gages and instruments, and light-duty plant machinery
- Each thickness is easily identified by its own color

Plastic Slotted Shim

Decimal Thickness	Color	Material	Pcs. Per Pkg.	1" x 1" Size AA 5/16" Slot		2" x 2" Size A 5/8" Slot		3" x 3" Size B 3/4" Slot	
				UPC No.	Lb. Wgt.	UPC No.	Lb. Wgt.	UPC No.	Lb. Wgt.
.0005	Silver	Polyester	20	42100	.01	42117	.01	42134	.02
.001	Amber	Polyester	20	42101	.01	42118	.02	42135	.02
.0015	Purple	Polyester	20	42102	.01	42119	.02	42136	.03
.002	Red	Polyester	20	42103	.01	42120	.02	42137	.03
.003	Green	Polyester	20	42104	.01	42121	.02	42138	.04
.004	Tan	Polyester	20	42105	.01	42122	.03	42139	.05
.005	Blue	Polyester	20	42106	.01	42123	.03	42140	.06
.0075	Matte	Vinyl	20	42107	.02	42124	.04	42141	.07
.010	Brown	Vinyl	20	42108	.02	42125	.05	42142	.09
.0125	Black	Vinyl	20	42109	.02	42126	.05	42143	.11
.015	Pink	Vinyl	20	42110	.02	42127	.06	42144	.13
.020	Yellow	Vinyl	20	42111	.02	42128	.08	42145	.17
.025	White	Vinyl	20	42112	.03	42129	.09	42146	.21
.030	Coral	Vinyl	20	42113	.03	42130	.11	42147	.24
.040	Clear	Vinyl	20	42114	.04	42131	.14	42148	.31
.050	Clear	Vinyl	20	42115	.04	42132	.17	42149	.39
.060	Clear	Vinyl	20	42116	.05	42133	.20	42150	.47
Asst.*	-		170	42904	.19	42905	.67	42906	1.45

* Asst.'s contain 10 pieces of each thickness listed above and are packaged in a sturdy chipboard box.

Laminated Shim

- Available in TYPE 1 (fully laminated) sheets
- TYPE 2 (1/2 solid stock) and TYPE 3 (3/4 solid stock) available on special order
- PRECISION BRAND Laminated Brass Shim (Comp. 2) is made from a half hard CDA 260 alloy
- PRECISION BRAND Laminated Aluminum Shim (Comp. 1) is made from an 1100 Series; H19, Series 5052 available on special order
- PRECISION BRAND Laminated Stainless Steel Shim (Comp. 3) is made from an annealed 300 Series Stainless
- PRECISION BRAND Laminated Steel Shim (Comp. 4) is made from a cold rolled 1008-1010 Carbon Steel

8" x 24" Laminated Brass Shim
(Composition 2)

12" x 24" Laminated Brass Shim
(Composition 2)

Sheet Thickness		.002 Laminations UPC No. (Class 1)	Sheet Lb. Wgt.	.003 Laminations UPC No. (Class 2)	.002 Laminations UPC No. (Class 1)	Sheet Lb. Wgt.	.003 Laminations UPC No. (Class 2)
Decimal	Metric (mm)						
.006	.152	70006	.38	-	70506	.57	-
.008	.203	70008	.50	-	70508	.75	-
.010	.254	70010	.60	-	70510	.90	-
.016	.406	70016	.95	70316	70516	1.42	70716
.021	.533	70021	1.20	70321	70521	1.80	70721
.032	.813	70032	1.90	70332	70532	2.80	70732
.048	1.219	70048	2.80	70348	70548	4.20	70748
.062	1.575	70062	3.80	70362	70562	5.70	70762
.094	2.388	70094	5.60	70394	70594	8.40	70794
.125	3.175	70125	7.50	70425	70625	11.30	70825

24" x 24" Laminated Aluminum Shim
(Composition 1)

20" x 24" Laminated Stainless Steel Shim
(Composition 3)

20" x 24" Laminated Steel Shim
(Composition 4)

Sheet Thickness		.002 Laminations UPC No. (Class 1)	Sheet Lb. Wgt.	.003 Laminations UPC No. (Class 2)	.002 Laminations UPC No. (Class 1)	Sheet Lb. Wgt.	.003 Laminations UPC No. (Class 2)	.002 Laminations UPC No. (Class 1)	Sheet Lb. Wgt.	.003 Laminations UPC No. (Class 2)
Decimal	Metric (mm)									
.006	.152	71006	.30	-	-	-	-	73006	.80	-
.008	.203	71008	.40	-	72008	1.20	-	73008	1.10	-
.010	.254	71010	.60	71310	72010	1.40	72310	73010	1.40	-
.016	.406	71016	.90	71316	72016	2.30	72316	73016	2.30	73316
.020	.508	-	-	-	72020	2.80	72320	73020	2.80	73320
.021	.533	71021	1.20	71321	-	-	-	-	-	-
.032	.813	71032	1.90	71332	72032	4.50	72332	73032	4.50	73332
.048	1.219	71048	2.80	71348	72048	6.70	72348	73048	6.70	73348
.062	1.575	71062	3.60	71362	72062	8.70	72362	73062	8.70	73362
.094	2.388	71094	5.30	71394	72094	13.20	72394	73094	13.20	73394
.125	3.175	71125	7.20	71425	72125	19.90	72425	73125	19.90	73425

Laminated Brass Arbor Shims



- PRECISION BRAND Laminated Brass Arbor Shims are made of cold rolled, half hard CDA 260 alloy with .002" laminations
- Peel off layers to needed thickness
- Allows you more accuracy on-site
- Composition 2, Type 1, Class 1
- I.D./O.D. Tolerances +/- .008

Laminated Brass Arbor Shims

I.D. x O.D. Size	Thickness			
	.020"/.508mm UPC No.	.032"/.813mm UPC No.	.062"/1.575mm UPC No.	.125"/3.175mm UPC No.
3/8 x 5/8	–	74105	74110	–
1/2 x 3/4	74050	74055	74060	–
5/8 x 1	74200	74205	74210	74215
3/4 x 1-1/8	74250	74255	74260	74265
7/8 x 1-3/8	74300	74305	74310	74315
1 x 1-1/2	74350	74355	74360	74365
1-1/4 x 1-3/4	74400	74405	74410	74415
1-3/8 x 1-7/8	74450	74455	74460	74465
1-1/2 x 2-1/8	74500	74505	74510	74515
1-3/4 x 2-3/4	74550	74555	74560	74565
2 x 2-3/4	74600	74605	74610	74615

Laminated Stainless Steel Arbor Shims



- Made of annealed type 302 stainless
- Peel off layers to needed thickness
- Corrosion resistant
- Allows you more accuracy on-site
- I.D. /O.D. Tolerances +/- .008
(+/- .010 for .125" thickness)

Laminated Stainless Steel Arbor Shims

I.D. x O.D. Size	Thickness			
	.020"/.508mm UPC No.	.032"/.813mm UPC No.	.062"/1.575mm UPC No.	.125"/3.175mm UPC No.
3/8 x 5/8	–	72500	72501	–
1/2 x 3/4	72502	72503	72504	–
5/8 x 1	72505	72506	72507	72508
3/4 x 1-1/8	72509	72510	72511	72512
7/8 x 1-3/8	72513	72514	72515	72516
1 x 1-1/2	72517	72518	72519	72520
1-1/4 x 1-3/4	72521	72522	72523	72524
1-3/8 x 1-7/8	72525	72526	72527	72528
1-1/2 x 2-1/8	72529	72530	72531	72532
1-3/4 x 2-3/4	72533	72534	72535	72536
2 x 2-3/4	72537	72538	72539	72540

Stainless Steel Arbor Shims



SHIMS do not have a keyway

- Made of 300 Series Stainless Steel Shim
- Packaged in air tight poly bags, 10 pieces per bag, unless otherwise indicated
- Special sizes, materials, spacers with keyway, and bulk quantities available on request
- Corrosion resistant
- Used for fast, accurate spacing of milling cutters, gang cutters, saws, slitting blades and grinding tools
- Tolerances:
I.D.: +.011"/-.000"
O.D.: +/- .002"



Stainless Steel Arbor Shims

Thickness		3/8" I.D. x 5/8" O.D.	1/2" I.D. x 3/4" O.D.	5/8" I.D. x 1" O.D.	3/4" I.D. x 1-1/8" O.D.	7/8" I.D. x 1-3/8" O.D.	1" I.D. x 1-1/2" O.D.
Decimal	Metric (mm)	Shim UPC No.	Shim UPC No.	Shim UPC No.	Shim UPC No.	Shim UPC No.	Shim UPC No.
.001	.025	84101	84121	84141	84161	84181	84201
.002	.051	84102	84122	84142	84162	84182	84202
.003	.076	84103	84123	84143	84163	84183	84203
.004	.102	84104	84124	84144	84164	84184	84204
.005	.127	84105	84125	84145	84165	84185	84205
.006	.152	84106	84126	84146	84166	84186	84206
.007	.178	84107	84127	84147	84167	84187	84207
.008	.203	84108	84128	84148	84168	84188	84208
.010	.254	84109	84129	84149	84169	84189	84209
.012	.305	84110	84130	84150	84170	84190	84210
.015	.381	84111	84131	84151	84171	84191	84211
.020	.508	84112	84132	84152	84172	84192	84212
.025	.635	84113	84133	84153	84173	84193	84213
.031	.787	84114	84134	84154	84174	84194	84214
.048	1.219	84115	84135	84155	84175	84195	84215
.062	1.575	84116	84136	84156	84176	84196	84216
.090	2.286	84117	84137	84157	84177	84197	84217
.125	3.175	84118	84138	84158	84178	84198	84218
Thickness		1-1/8" I.D. x 1-5/8" O.D.	1-1/4" I.D. x 1-3/4" O.D.	1-3/8" I.D. x 1-7/8" O.D.	1-1/2" I.D. x 2-1/8" O.D.	1-3/4" I.D. x 2-3/4" O.D.	2" I.D. x 2-3/4" O.D.
Decimal	Metric (mm)	Shim UPC No.	Shim UPC No.	Shim UPC No.	Shim UPC No.	Shim UPC No.	Shim UPC No.
.001	.025	84221	84241	84261	84441	84301	84461
.002	.051	84222	84242	84262	84442	84302	84462
.003	.076	84223	84243	84263	84443	84303	84463
.004	.102	84224	84244	84264	84444	84304	84464
.005	.127	84225	84245	84265	84445	84305	84465
.006	.152	84226	84246	84266	84446	84306	84466
.007	.178	84227	84247	84267	84447	84307	84467
.008	.203	84228	84248	84268	84448	84308	84468
.010	.254	84229	84249	84269	84449	84309	84469
.012	.305	84230	84250	84270	84450	84310	84470
.015	.381	84231	84251	84271	84451	84311	84471
.020	.508	84232	84252	84272	84452	84312	84472
.025	.635	84233	84253	84273	84453	84313	84473
.031	.787	84234	84254	84274	84454	84314	84474
.048	1.219	84235	84255	84275	*84455	*84315	*84475
.062	1.575	84236	84256	84276	*84456	*84316	*84476
.090	2.286	*84237	*84257	*84277	*84457	*84317	*84477
.125	3.175	*84238	*84258	*84278	*84458	*84318	*84478

* 5 per package.

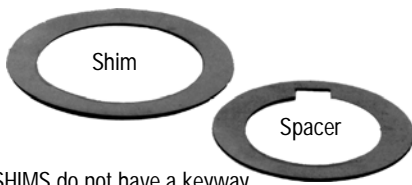

SHIMS do not have a keyway,
SPACERS do have a keyway

Arbor Spacers & Shims

- Made of high quality Low Carbon, Cold Rolled, Full Hard, Steel Shim
- Keyways conform to American standards
- Packaged in air tight poly bags, 10 pieces per bag (except assortments)
- Special sizes, materials and bulk quantities available on request

- Used for fast, accurate spacing of milling cutters, gang cutters, saws, slitting blades and grinding tools
- Assortment kits also available (see page 40)
- Tolerances:
ID: +.011"/-.000"
OD: +/--.002"

Arbor Shims

1/4" I.D. x 3/8" O.D.						11/32" I.D. x 13/16" O.D.					
Thickness		Shims Without Keyway UPC No.	Thickness		Shims Without Keyway UPC No.	Thickness		Shims Without Keyway UPC No.	Thickness		Shims Without Keyway UPC No.
Decimal	Metric (mm)		Decimal	Metric (mm)		Decimal	Metric (mm)		Decimal	Metric (mm)	
.001	.025	25081	.012	.305	25091	.001	.025	25481	.012	.305	25491
.0015	.038	25082	.015	.381	25092	.0015	.038	25482	.015	.381	25492
.002	.051	25083	.020	.508	25093	.002	.051	25483	.020	.508	25493
.003	.076	25084	.025	.635	25094	.003	.076	25484	.025	.635	25494
.004	.102	25085	.031	.787	25095	.004	.102	25485	.031	.787	25495
.005	.127	25086	.047	1.194	25096	.005	.127	25486	.047	1.194	25496
.006	.152	25087	.062	1.575	25097	.006	.152	25487	.062	1.575	25497
.007	.178	25088	.093	2.362	25098	.007	.178	25488	.093	2.362	25498
.008	.203	25089	.125	3.175	25099	.008	.203	25489	.125	3.175	25499
.010	.254	25090	Asst.*	-	25100	.010	.254	25490	Asst.*	-	25500

Arbor Spacers & Shims

Thickness		3/8" I.D. x 5/8" O.D.		1/2" I.D. x 3/4" O.D.		5/8" I.D. x 1" O.D.		3/4" I.D. x 1-1/8" O.D.		7/8" I.D. x 1-3/8" O.D.		1" I.D. x 1-1/2" O.D.	
Decimal	Metric (mm)	Spacers With 1/8" x 3/64" Keyway UPC No.		Shims Without Keyway UPC No.		Spacers With 3/16" x 1/16" Keyway UPC No.		Shims Without Keyway UPC No.		Spacers With 3/16" x 5/64" Keyway UPC No.		Shims Without Keyway UPC No.	
		Spacers With 1/8" x 3/64" Keyway UPC No.	Shims Without Keyway UPC No.	Spacers With 3/16" x 1/16" Keyway UPC No.	Shims Without Keyway UPC No.	Spacers With 3/16" x 5/64" Keyway UPC No.	Shims Without Keyway UPC No.	Spacers With 3/16" x 5/64" Keyway UPC No.	Shims Without Keyway UPC No.	Spacers With 1/4" x 3/32" Keyway UPC No.	Shims Without Keyway UPC No.		
.001	.025	24101	25101	24121	25121	24141	25141	24161	25161	24181	25181	24201	25201
.0015	.038	24102	25102	24122	25122	24142	25142	24162	25162	24182	25182	24202	25202
.002	.051	24103	25103	24123	25123	24143	25143	24163	25163	24183	25183	24203	25203
.003	.076	24104	25104	24124	25124	24144	25144	24164	25164	24184	25184	24204	25204
.004	.102	24105	25105	24125	25125	24145	25145	24165	25165	24185	25185	24205	25205
.005	.127	24106	25106	24126	25126	24146	25146	24166	25166	24186	25186	24206	25206
.006	.152	24107	25107	24127	25127	24147	25147	24167	25167	24187	25187	24207	25207
.007	.178	24108	25108	24128	25128	24148	25148	24168	25168	24188	25188	24208	25208
.008	.203	24109	25109	24129	25129	24149	25149	24169	25169	24189	25189	24209	25209
.010	.254	24110	25110	24130	25130	24150	25150	24170	25170	24190	25190	24210	25210
.012	.305	24111	25111	24131	25131	24151	25151	24171	25171	24191	25191	24211	25211
.015	.381	24112	25112	24132	25132	24152	25152	24172	25172	24192	25192	24212	25212
.020	.508	24113	25113	24133	25133	24153	25153	24173	25173	24193	25193	24213	25213
.025	.635	24114	25114	24134	25134	24154	25154	24174	25174	24194	25194	24214	25214
.031	.787	24115	25115	24135	25135	24155	25155	24175	25175	24195	25195	24215	25215
.047	1.194	24116	25116	24136	25136	24156	25156	24176	25176	24196	25196	24216	25216
.062	1.575	24117	25117	24137	25137	24157	25157	24177	25177	24197	25197	24217	25217
.093	2.362	24118	25118	24138	25138	24158	25158	24178	25178	24198	25198	24218	25218
.125	3.175	24119	25119	24139	25139	24159	25159	24179	25179	24199	25199	24219	25219
Asst.*	-	24120	25120	24140	25140	24160	25160	24180	25180	24200	25200	24220	25220

* Assortments contain one each of the 19 different thicknesses.

Arbor Spacers & Shims

Arbor Spacers & Shims

Thickness		1-1/8" I.D. x 1-5/8" O.D.		1-1/4" I.D. x 1-3/4" O.D.		1-3/8" I.D. x 1-7/8" O.D.		1-1/2" I.D. x 2-1/8" O.D.		1-3/4" I.D. x 2-3/4" O.D.		2" I.D. x 2-3/4" O.D.	
Decimal	Metric (mm)	Spacers With 1/4" x 3/32" Keyway UPC No.		Shims Without Keyway UPC No.		Spacers With 5/16" x 1/8" Keyway UPC No.		Shims Without Keyway UPC No.		Spacers With 3/8" x 5/32" Keyway UPC No.		Shims Without Keyway UPC No.	
		.001	.025	24221	25221	24241	25241	24261	25261	24441	25441	24301	25301
.0015	.038	24222	25222	24242	25242	24262	25262	24442	25442	24302	25302	24462	25462
.002	.051	24223	25223	24243	25243	24263	25263	24443	25443	24303	25303	24463	25463
.003	.076	24224	25224	24244	25244	24264	25264	24444	25444	24304	25304	24464	25464
.004	.102	24225	25225	24245	25245	24265	25265	24445	25445	24305	25305	24465	25465
.005	.127	24226	25226	24246	25246	24266	25266	24446	25446	24306	25306	24466	25466
.006	.152	24227	25227	24247	25247	24267	25267	24447	25447	24307	25307	24467	25467
.007	.178	24228	25228	24248	25248	24268	25268	24448	25448	24308	25308	24468	25468
.008	.203	24229	25229	24249	25249	24269	25269	24449	25449	24309	25309	24469	25469
.010	.254	24230	25230	24250	25250	24270	25270	24450	25450	24310	25310	24470	25470
.012	.305	24231	25231	24251	25251	24271	25271	24451	25451	24311	25311	24471	25471
.015	.381	24232	25232	24252	25252	24272	25272	24452	25452	24312	25312	24472	25472
.020	.508	24233	25233	24253	25253	24273	25273	24453	25453	24313	25313	24473	25473
.025	.635	24234	25234	24254	25254	24274	25274	24454	25454	24314	25314	24474	25474
.031	.787	24235	25235	24255	25255	24275	25275	24455	25455	24315	25315	24475	25475
.047	1.194	24236	25236	24256	25256	24276	25276	24456	25456	24316	25316	24476	25476
.062	1.575	24237	25237	24257	25257	24277	25277	24457	25457	24317	25317	24477	25477
.093	2.362	24238	25238	24258	25258	24278	25278	24458	25458	24318	25318	24478	25478
.125	3.175	24239	25239	24259	25259	24279	25279	24459	25459	24319	25319	24479	25479
Asst.*	-	24240	25240	24260	25260	24280	25280	24460	25460	24320	25320	24480	25480

* Assortments contain one each of the 19 different thicknesses

Arbor Shim Assortment Kits



- PRECISION BRAND Arbor Shim Assortment Kits contain the most commonly used Arbor Shims
- Made of high quality Steel Shim; low carbon cold rolled steel
- Plastic compartment boxes are easy to store
- Refill packages available, see above and page 39

Arbor Shim Assortment Kits

Assortment Thicknesses	Assortment Sizes	Assortment UPC No.
.005	3/8" x 5/8"	25998*
.010	1/2" x 3/4"	
.015	5/8" x 1"	
	3/4" x 1-1/8"	25999*
.020	7/8" x 1-3/8"	
.031	3/8" x 5/8"	
.125	1/2" x 3/4"	25999*
	5/8" x 1"	
	3/4" x 1-1/8"	25999*
	1" x 1-1/2"	

* Assortment contains 10 pieces of each thickness in each size, for a total of 150 pieces.



- PRECISION BRAND Plastic Arbor Shims are used for light duty spacing
- Used for fast, accurate spacing of milling cutters, gang cutters, saws and grinding tools
- Easy identification because the color tells the thickness
- Corrosion resistant
- Non-magnetic
- 10 pieces per package
- Larger and thicker shims are available on special order

- Tolerances:
ID: +.005"/-.015"
OD: +.005"/-.005"

Plastic Arbor Shims

Thickness		Color	3/8" I.D.	1/2" I.D.	5/8" I.D.	3/4" I.D.	7/8" I.D.	1" I.D.
Decimal	Metric (mm)		X 5/8" O.D. UPC No.	X 3/4" O.D. UPC No.	X 1" O.D. UPC No.	X 1-1/8" O.D. UPC No.	X 1-3/8" O.D. UPC No.	X 1-1/2" O.D. UPC No.
.001	.025	Amber	44701	44715	44729	44743	44757	44771
.0015	.038	Purple	44702	44716	44730	44744	44758	44772
.002	.051	Red	44703	44717	44731	44745	44759	44773
.003	.076	Green	44704	44718	44732	44746	44760	44774
.004	.102	Tan	44705	44719	44733	44747	44761	44775
.005	.127	Blue	44706	44720	44734	44748	44762	44776
.0075	.191	Matte	44707	44721	44735	44749	44763	44777
.010	.254	Brown	44708	44722	44736	44750	44764	44778
.0125	.318	Black	44709	44723	44737	44751	44765	44779
.015	.381	Pink	44710	44724	44738	44752	44766	44780
.020	.508	Yellow	44711	44725	44739	44753	44767	44781
.025	.635	White	44712	44726	44740	44754	44768	44782
.030	.762	Coral	44713	44727	44741	44755	44769	44783
Asst.*	-	-	44714	44728	44742	44756	44770	44784

* Assortment includes one of each thickness listed above.

Plastic Arbor Shims

Thickness		Color	1-1/8" I.D.	1-1/4" I.D.	1-3/8" I.D.	1-1/2" I.D.	1-3/4" I.D.	2" I.D.
Decimal	Metric (mm)		X 1-5/8" O.D. UPC No.	X 1-3/4" O.D. UPC No.	X 1-7/8" O.D. UPC No.	X 2-1/8" O.D. UPC No.	X 2-3/4" O.D. UPC No.	X 2-3/4" O.D. UPC No.
.001	.025	Amber	44785	44799	44813	44827	44841	44855
.0015	.038	Purple	44786	44800	44814	44828	44842	44856
.002	.051	Red	44787	44801	44815	44829	44843	44857
.003	.076	Green	44788	44802	44816	44830	44844	44858
.004	.102	Tan	44789	44803	44817	44831	44845	44859
.005	.127	Blue	44790	44804	44818	44832	44846	44860
.0075	.191	Matte	44791	44805	44819	44833	44847	44861
.010	.254	Brown	44792	44806	44820	44834	44848	44862
.0125	.318	Black	44793	44807	44821	44835	44849	44863
.015	.381	Pink	44794	44808	44822	44836	44850	44864
.020	.508	Yellow	44795	44809	44823	44837	44851	44865
.025	.635	White	44796	44810	44824	44838	44852	44866
.030	.762	Coral	44797	44811	44825	44839	44853	44867
Asst.*	-	-	44798	44812	44826	44840	44854	44868

* Assortment includes one of each thickness listed above.

Die Button Shims

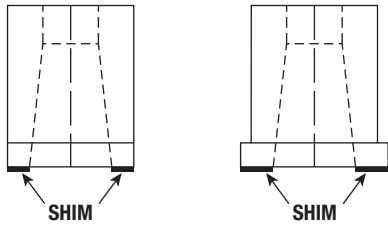

- Shims quickly adjust height of sharpened die button
- Easily extends the "life" of a die button
- Saves time over hand punching custom shims
- Large I.D. accommodates multiple size die openings and reduces the risk of "slug stacking"
- Hardened steel maintains precision thickness under heavy pressure
- .005" thickness is made from 1095 blue tempered spring steel
- .015" and .032" thickness is made from 1075 tempered spring steel
- Available in assortment and refill packages

Die Button Shims

Thickness	Button Size	Max. O.D.	Min. I.D.	Pcs. Per Pkg.	UPC No.	Lb. Wgt.
.005"	1/4"	.249"	.17"	50	26900	.01
.015"	1/4"	.249"	.17"	50	26901	.01
.032"	1/4"	.249"	.17"	25	26802	.01
.005"	5/16"	.3115"	.23"	50	26903	.01
.015"	5/16"	.3115"	.23"	50	26904	.01
.032"	5/16"	.3115"	.23"	25	26805	.01
.005"	3/8"	.374"	.285"	50	26906	.01
.015"	3/8"	.374"	.285"	50	26907	.01
.032"	3/8"	.374"	.285"	25	26808	.01
.005"	7/16"	.4365"	.31"	50	26909	.01
.015"	7/16"	.4365"	.31"	50	26910	.02
.032"	7/16"	.4365"	.31"	25	26811	.02
.005"	1/2"	.499"	.35"	50	26912	.02
.015"	1/2"	.499"	.35"	50	26913	.02
.032"	1/2"	.499"	.35"	25	26814	.02
.005"	5/8"	.624"	.47"	50	26915	.01
.015"	5/8"	.624"	.47"	50	26916	.03
.032"	5/8"	.624"	.47"	25	26817	.03
.005"	3/4"	.749"	.595"	50	26918	.02
.015"	3/4"	.749"	.595"	50	26919	.04
.032"	3/4"	.749"	.595"	25	26820	.04
.005"	7/8"	.874"	.625"	50	26921	.03
.015"	7/8"	.874"	.625"	50	26922	.06
.032"	7/8"	.874"	.625"	25	26823	.06
.005"	1"	.999"	.75"	50	26924	.03
.015"	1"	.999"	.75"	50	26925	.07
.032"	1"	.999"	.75"	25	26826	.07
Asst.*	-	-	-	450	26930	.46

* Assortment contains 25 pieces of each .005" and .015" thick sizes listed above.

Metric Die Button Shims



- Metric die button shims are made from 302 full hard stainless steel

* Assortment contains 10 of each size listed above.

Button Size (mm)	Thickness (mm)	Pcs. per Pkg.	UPC No.	Lb. Wgt.	Button Size (mm)	Thickness (mm)	Pcs. per Pkg.	UPC No.	Lb. Wgt.
6	.125	25	26931	.01	13	.40	25	26993	.02
6	.25	25	26932	.01	13	.50	25	26994	.02
6	.40	25	26933	.01	13	.65	25	26995	.03
8	.125	25	26937	.01	13	.80	25	26996	.03
8	.25	25	26938	.01	16	.125	25	26997	.01
8	.40	25	26939	.01	16	.25	25	26978	.02
8	.50	25	26940	.01	16	.40	25	26979	.02
8	.65	25	26941	.01	16	.50	25	26980	.02
8	.80	25	26942	.01	16	.65	25	26981	.03
10	.125	25	26943	.01	16	.80	25	26982	.03
10	.25	25	26944	.01	20	.125	25	26983	.01
10	.40	25	26945	.01	20	.25	25	26984	.02
10	.50	25	26946	.01	20	.40	25	26985	.02
10	.65	25	26947	.01	20	.50	25	26986	.03
10	.80	25	26948	.01	20	.65	25	26987	.04
13	.125	25	26991	.01	20	.80	25	26988	.04
13	.25	25	26992	.01	Asst.*		330	26989	.75

Shoulder Screw/Stripper Bolt Shims

(Lengthening & Shortening Shims) [View this product demo on the web!](#)

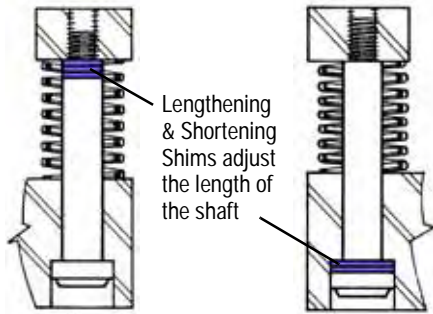

Lengthening Shims

Shortening Shims

- PRECISION BRAND Lengthening Shims fit over the stripper screw threads and under the shoulder which, in effect, lengthens the stripper screw length
- PRECISION BRAND Shortening Shims are precision die cut to fit with close tolerances around the shoulder screw shank to fit under the screw head
- Fits six different shoulder screw sizes from 1/4" to 3/4" diameter
- .005" shims are precision die cut from 1095 blue tempered spring steel
- .015" and .032" shims are die cut from 1075 tempered spring steel



Scan this QR Code with your Smartphone and watch our product demo directly from your phone!



Lengthening Shims

Decimal Size		Screw Size	Decimal Thickness	Bulk (50 Pcs.) UPC No.	Super Bulk (1000 Pcs.) UPC No.
I.D.	O.D.				
.171	.248	1/4"	.005	26051	26031
.171	.248	1/4"	.015	26052	26032
.187	.248	1/4"	.032	26053	26033
.234	.308	5/16"	.005	26054	26034
.234	.308	5/16"	.015	26055	26035
.234	.308	5/16"	.032	26056	26036
.289	.371	3/8"	.005	26057	26037
.289	.371	3/8"	.015	26058	26038
.296	.371	3/8"	.032	26059	26039
.352	.496	1/2"	.005	26060	26040
.352	.496	1/2"	.015	26061	26041
.352	.496	1/2"	.032	26062	26042
.473	.621	5/8"	.005	26063	26043
.473	.621	5/8"	.015	26064	26044
.473	.621	5/8"	.032	26065	26045
.598	.746	3/4"	.005	26066	26046
.598	.746	3/4"	.015	26067	26047
.598	.746	3/4"	.032	26068	26048

Lengthening Shim Assortment **UPC No. 26005** (15 of each size listed above, 270 total pieces)

Lengthening Shim Kit **UPC No. 26999** (50 of each .015" thickness listed above, 300 total pieces)

Shortening Shims

Decimal Size		Screw Size	Decimal Thickness	Bulk (50 Pcs.) UPC No.	Super Bulk (1000 Pcs.) UPC No.
I.D.	O.D.				
.252	.366	1/4"	.005	26151	26131
.252	.366	1/4"	.015	26152	26132
.252	.366	1/4"	.032	26153	26133
.313	.424	5/16"	.005	26154	26134
.313	.424	5/16"	.015	26155	26135
.313	.424	5/16"	.032	26156	26136
.376	.557	3/8"	.005	26157	26137
.376	.557	3/8"	.015	26158	26138
.376	.557	3/8"	.032	26159	26139
.501	.738	1/2"	.005	26160	26140
.501	.738	1/2"	.015	26161	26141
.501	.738	1/2"	.032	26162	26142
.626	.870	5/8"	.005	26163	26143
.626	.870	5/8"	.015	26164	26144
.626	.870	5/8"	.032	26165	26145
.751	.995	3/4"	.005	26166	26146
.751	.995	3/4"	.015	26167	26147
.751	.995	3/4"	.032	26168	26148

Shortening Shim Assortment **UPC No. 26010** (15 of each size listed above, 270 total pieces)

Metric Shoulder Screw/Stripper Bolt Shims

(Metric Lengthening & Shortening Shims)



- PRECISION BRAND Metric Lengthening Shims fit over the stripper screw threads and under the shoulder which, in effect, lengthens the stripper screw length
- PRECISION BRAND Metric Shortening Shims are precision die cut to fit perfectly with close tolerances around the shoulder screw shank to fit under the screw head
- Both PRECISION BRAND Metric Lengthening and Shortening Shims are made from 302 full hard stainless steel



Metric Lengthening Shims

Screw Size (mm)	Thickness (mm)	Bulk (25 Pcs.) UPC No.	Lb. Weight
6	.125	26501	.01
6	.25	26502	.01
6	.40	26503	.01
8	.125	26504	.01
8	.25	26505	.01
8	.40	26506	.01
8	.50	26507	.01
8	.65	26508	.01
8	.80	26509	.01
10	.125	26510	.01
10	.25	26511	.01
10	.40	26512	.01
10	.50	26513	.01
10	.65	26514	.01
10	.80	26515	.01
12	.125	26516	.01
12	.25	26517	.01
12	.40	26518	.01
12	.50	26519	.01
12	.65	26520	.01
12	.80	26521	.02
16	.125	26522	.01
16	.25	26523	.02
16	.40	26524	.02
16	.50	26525	.02
16	.65	26526	.03
16	.80	26527	.04
20	.125	26528	.01
20	.25	26529	.02
20	.40	26530	.02
20	.50	26531	.03
20	.65	26532	.04
20	.80	26533	.04

Metric Lengthening Shim Assortment **UPC No. 26500** (10 each of each size listed above, 330 total pieces)

Metric Shortening Shims

Screw Size (mm)	Thickness (mm)	Bulk (25 Pcs.) UPC No.	Lb. Weight
6	.125	26601	.01
6	.25	26602	.01
6	.40	26603	.01
6	.50	26604	.01
6	.65	26605	.02
6	.80	26606	.02
8	.125	26607	.01
8	.25	26608	.01
8	.40	26609	.02
8	.50	26610	.02
8	.65	26611	.03
8	.80	26612	.03
10	.125	26613	.01
10	.25	26614	.02
10	.40	26615	.02
10	.50	26616	.03
10	.65	26617	.04
10	.80	26618	.04
12	.125	26619	.01
12	.25	26620	.02
12	.40	26621	.03
12	.50	26622	.03
12	.65	26623	.04
12	.80	26624	.05
16	.125	26625	.02
16	.25	26626	.03
16	.40	26627	.04
16	.50	26628	.06
16	.65	26629	.08
16	.80	26630	.08
20	.125	26631	.03
20	.25	26632	.05
20	.40	26633	.08
20	.50	26634	.09
20	.65	26635	.11
20	.80	26636	.13

Metric Shortening Shim Assortment **UPC No. 26600** (10 each of each size listed above, 360 total pieces)

- PRECISION BRAND Ground Flat Stock is made from general purpose tool steel
- Ideal material for tools, dies, punches, templates, stripper plates and general precision machine parts
- Pre-ground on all surfaces to close tolerances
- An electric furnace melt tool steel
- Fully spheroidized structure

18" Lengths 0-1 Oil Hardening Ground Flat Stock

Size		UPC No.
Thickness	Width	
1/16"	1/2"	30040
	3/4"	30041
	1"	30042
	1-1/4"	30043
	1-1/2"	30044
	1-3/4"	30045
	2"	30046
	2-1/2"	30047
	3"	30048
	3-1/2"	30049
4"	30050	
5/64"	1/2"	30060
	3/4"	30061
	1"	30062
	1-1/2"	30063
2"	30064	
3/32"	1/2"	30070
	3/4"	30071
	1"	30072
	1-1/4"	30073
	1-1/2"	30074
	2"	30075
	2-1/2"	30076
3"	30077	
7/64"	1/2"	30082
	3/4"	30083
	1"	30084
	1-1/4"	30085
	1-1/2"	30086
	2"	30087
3"	30088	
4"	30089	
1/8"	1/8"	30100
	1/2"	30101
	5/8"	30102
	3/4"	30103
	1"	30104
	1-1/4"	30105
	1-1/2"	30106
	1-3/4"	30107
	2"	30108
	2-1/2"	30109

18" Lengths 0-1 Oil Hardening Ground Flat Stock

Size		UPC No.
Thickness	Width	
1/8"(cont.)	3"	30110
	3-1/2"	30111
	4"	30112
	4-1/2"	30113
	5"	30114
	6"	30115
5/32"	5/32"	30130
	1/2"	30131
	3/4"	30132
	1"	30133
	1-1/4"	30134
	1-1/2"	30135
	1-3/4"	30136
	3/16"	30150
	1/2"	30151
	3/4"	30152
3/16"	1"	30153
	1-1/4"	30154
	1-1/2"	30155
	1-3/4"	30156
	2"	30157
	2-1/2"	30158
	3"	30159
	3-1/2"	30160
	4"	30161
	5"	30162
6"	30163	
7/32"	7/32"	30170
	1/2"	30171
	3/4"	30172
	1"	30173
	1-1/4"	30174
	1-1/2"	30175
	2"	30176
	3"	30177
	4"	30178
	6"	30179
1/4"	1/4"	30180
	1/2"	30181
	3/4"	30182
	1"	30183
	1-1/4"	30184
	1-1/2"	30185
	1-3/4"	30186
	2"	30187
	2-1/2"	30188
	3"	30189
3-1/2"	30190	
4"	30191	
4-1/2"	30192	
5"	30193	
5-1/2"	30194	
6"	30195	

18" Lengths 0-1 Oil Hardening Ground Flat Stock

Size		UPC No.
Thickness	Width	
5/16"	5/16"	30225
	1/2"	30226
	3/4"	30227
	1"	30228
	1-1/4"	30229
	1-1/2"	30230
	1-3/4"	30231
	2"	30232
	2-1/2"	30233
	3"	30234
3/8"	3-1/2"	30235
	4"	30236
	3/8"	30250
	1/2"	30251
	3/4"	30252
	1"	30253
1/2"	1-1/4"	30254
	1-1/2"	30255
	1-3/4"	30256
	2"	30257
	2-1/2"	30258
	3"	30259
	3-1/2"	30260
	4"	30261
	1/2"	30281
	5/8"	30282
3/4"	30283	
1"	30284	
1-1/4"	30285	
1-1/2"	30286	
2"	30287	
2-1/2"	30288	
3"	30289	
3-1/2"	30290	
4"	30291	
4-1/2"	30292	
5"	30293	
6"	30294	
5/8"	5/8"	30310
	3/4"	30311
	1"	30312
3/4"	3/4"	30330
	1"	30331
	1-1/4"	30332
1"	1-1/2"	30333
	2"	30334
	1"	30360
	1-1/4"	30361
	1-1/2"	30362
	2"	30363
	2-1/2"	30364
	3"	30365
	3-1/2"	30366
	4"	30367

Standard Series Hose Clamps



100% INTERLOCK CONSTRUCTION FEATURES:
One piece housing which directly locks into the band. Spot weld free design.



Engineered for Tough Installation

- Rounded edges to protect the hose
- Efficient three-piece construction
- No spot welds to corrode
- Easily installed with screwdriver, nut driver or socket wrench
- Screws feature deep slots for quick installation
- Meets or exceeds SAE torque specifications
- Sold in box quantities of 10
- Bulk quantities also available

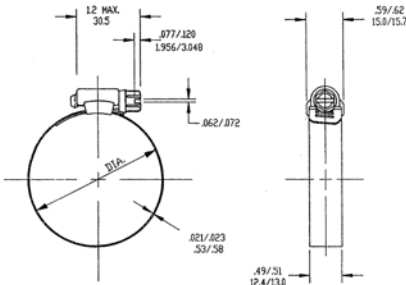

B-H Series Partial Stainless

This clamp has a 1/2" stainless steel band with plated 5/16" slotted hex-head screw and housing. It is recommended for most applications.

B-HS Series All Stainless

The 1/2" band and housing components are all stainless steel. The slotted 5/16" hex-head screw is made from 400 series stainless steel. It is recommended for good corrosion resistance and extra strength.

B-HSP Series

All 300 Series Stainless Steel

This high quality 300 series 1/2" band and housing is matched with a 300 series 5/16" slotted hex-head screw. This clamp is highly corrosion resistant, well suited for marine applications and is low in magnetic permeability.

Standard Series Hose Clamps

Clamp Diameter				Std. Ctn.	Lbs. Per 100 Clamps	B-H Series Partial Stainless		B-HS Series All Stainless		B-HSP Series All 300 Series Stainless	
Fraction		Metric (mm)				Clamp No.	UPC No.	Clamp No.	UPC No.	Clamp No.	UPC No.
Min.	Max.	Min.	Max.								
3/8"	7/8"	9.5	22.2	500	4	B6H 35125	B6HS 35130	B6HSP 35700			
7/16"	1"	11.1	25.4	500	4	B8H 35155	B8HS 35160	B8HSP 35705			
9/16"	1-1/16"	14.3	27.0	500	4	B10H 35185	B10HS 35190	B10HSP 35710			
9/16"	1-1/4"	14.3	31.7	500	4	B12H 35215	B12HS 35220	B12HSP 35715			
11/16"	1-1/2"	17.5	38.1	500	5	B16H 35245	B16HS 35250	B16HSP 35720			
3/4"	1-3/4"	19.1	44.4	500	5	B20H 35275	B20HS 35280	B20HSP 35725			
1-1/16"	2"	27.0	50.8	500	5	B24H 35305	B24HS 35310	B24HSP 35730			
1-5/16"	2-1/4"	33.3	57.2	500	6	B28H 35325	B28HS 35330	B28HSP 35735			
1-9/16"	2-1/2"	39.7	63.5	500	6	B32H 35345	B32HS 35350	B32HSP 35740			
1-13/16"	2-3/4"	46.0	69.9	500	7	B36H 35365	B36HS 35370	B36HSP 35745			
2-1/16"	3"	52.4	76.2	200	7	B40H 35385	B40HS 35390	B40HSP 35750			
2-5/16"	3-1/4"	58.7	82.6	200	8	B44H 35405	B44HS 35410	B44HSP 35755			
2-9/16"	3-1/2"	65.1	88.9	200	8	B48H 35425	B48HS 35430	B48HSP 35760			
2-13/16"	3-3/4"	71.4	95.3	100	8	B52H 35445	B52HS 35450	B52HSP 35765			
3-1/16"	4"	77.8	101.6	100	9	B56H 35465	B56HS 35470	B56HSP 35770			
3-5/16"	4-1/4"	84.1	108.0	100	9	B60H 35485	B60HS 35490	B60HSP 35775			
3-9/16"	4-1/2"	90.5	114.3	100	9	B64H 35505	B64HS 35510	B64HSP 35780			
4-1/16"	5"	103.2	127.0	100	10	B72H 35525	B72HS 35530	B72HSP 35785			
4-5/8"	5-1/2"	117.5	139.7	100	10	B80H 35545	B80HS 35550	B80HSP 35790			
4-3/32"	6"	104.0	152.4	100	11	B88H 35565	B88HS 35570	B88HSP 35795			
4-1/2"	6-1/2"	114.3	165.1	100	12	B96H 35585	B96HS 35590	B96HSP 35800			
5"	7"	127.0	177.8	100	13	B104H 35605	B104HS 35610	B104HSP 35805			
5-3/4"	7-3/4"	146.1	196.9	50	14	B116H 35625	B116HS 35630	B116HSP 35810			
5-1/2"	8-7/16"	139.7	214.3	200	14	-	-	B128HSP* 35820			
6-3/4"	9-11/16"	171.5	246.1	200	14	-	-	B148HSP* 35825			
7"	9-15/16"	177.8	252.4	200	15	-	-	B152HSP* 35827			
7-1/2"	10-7/16"	190.5	265.1	200	15	-	-	B160HSP* 35830			
9-1/2"	12-7/16"	241.3	315.9	200	18	-	-	B192HSP* 35835			
11-1/2"	14-7/16"	292.1	366.7	200	21	-	-	B224HSP* 35840			
14"	16-15/16"	355.6	430.2	200	25	-	-	B264HSP* 35845			

* 4-piece construction

Note: Additional sizes available on request.

Miniature Series Hose Clamps

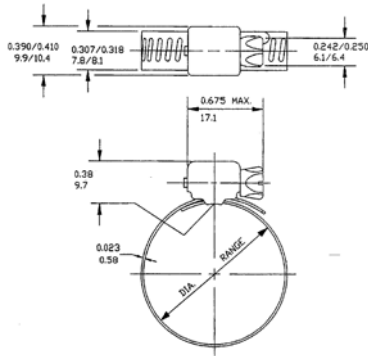

Micro Seal® Miniature Hose Clamps

- Seven sizes – the widest selection in the industry
- Small enough to install in very tight places
- Strong enough to give a tight, lasting seal that won't shake loose
- Applications: hose and tubing, fuel lines, air lines, fluid lines, etc.
- Sold in box quantities of 10
- Bulk quantities also available

M-P Series Partial Stainless

The 5/16" band is made of a 300 series stainless steel, and the housing and 1/4" hex-head screw are made from a plated carbon steel.

M-S Series All Stainless

The 5/16" band and housing are made of a 300 series stainless steel with a 400 series 1/4" hex-head screw.

M-HSP Series All Stainless

The 5/16" band, housing and 1/4" hex-head screw are made from a 300 series stainless steel.

Micro Seal® Miniature Series Hose Clamps

Clamp Diameter				Std. Ctn.	Lbs. Per 100 Clamps	M-P Series Partial Stainless		M-S Series All Stainless		M-HSP Series All Stainless	
Fraction		Metric (mm)				Clamp No.	UPC No.	Clamp No.	UPC No.	Clamp No.	UPC No.
Min.	Max.	Min.	Max.								
7/32"	5/8"	5.6	15.9	500	2	M4P	33000	M4S	33010	M4HSP	33500
5/16"	7/8"	7.9	22.2	500	2	M6P	33030	M6S	33040	M6HSP	33510
7/16"	1"	11.1	25.4	500	2	M8P	33070	M8S	33080	–	–
1/2"	1-1/16"	12.7	27.0	500	2	M10P	33100	M10S	33110	–	–
9/16"	1-1/4"	14.3	31.8	500	2	M12P	33150	M12S	33160	–	–
11/16"	1-1/2"	17.5	38.1	500	2	M16P	33200	M16S	33210	–	–
7/8"	1-3/4"	22.2	44.5	500	2	M20P	33250	M20S	33260	–	–

Shielded/Lined Hose Clamps



- Provides maximum protection for all soft hoses while ensuring a strong, positive seal
- Band, liner and housing are made from stainless steel
- Plated 5/16" slotted hex-head screw
- Inner liner covers band serrations which prevents hose damage
- Sold in box quantities of 10

Shielded/Lined Hose Clamps

Clamp Diameter		Clamp No.	UPC No.
Min.	Max.		
5/8"	3/4"	B6HL	35126
5/8"	13/16"	B8HL	35156
3/4"	15/16"	B10HL	35186
3/4"	1-1/8"	B12HL	35216
13/16"	1-3/8"	B16HL	35246
1-1/8"	1-5/8"	B20HL	35276
1-3/16"	1-15/16"	B24HL	35306
1-5/16"	2-1/4"	B28HL	35326
1-9/16"	2-1/2"	B32HL	35346
1-13/16"	2-3/4"	B36HL	35366
2-1/16"	3"	B40HL	35386
2-5/16"	3-1/4"	B44HL	35406
2-9/16"	3-1/2"	B48HL	35426
2-13/16"	3-3/4"	B52HL	35446
3-1/16"	4"	B56HL	35466
3-5/16"	4-1/4"	B60HL	35486
3-9/16"	4-1/2"	B64HL	35506
4-1/16"	5"	B72HL	35526

9/16" Band – Heavy Duty 3-Piece Hose Clamps

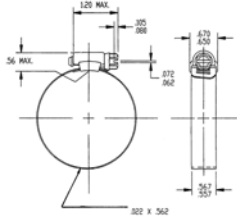
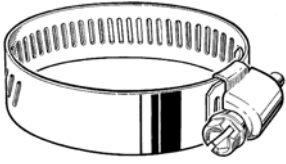

- 9/16" band width offers greater sealing area
- One-piece, spot weld free housing
- Wide range of applications including automotive, plumbing, and heavy duty industrial

HD-H Series Partial Stainless

- 9/16" band & housing are 200/300 series stainless steel
- 5/16" zinc plated carbon steel hex-head screw

HD-S Series All 300 Stainless

- 9/16" band & housing are 300 series stainless steel
- 5/16" hex-head screw is 300 series stainless steel

9/16" Band – Heavy Duty Hose Clamps

Clamp Diameter				Partial Stainless		All Stainless	
Fraction		Metric (mm)		Clamp No.	UPC No.	Clamp No.	UPC No.
Min.	Max.	Min.	Max.				
3/8"	7/8"	10.0	22.0	–	–	HD6S	47809
7/16"	1"	11.0	25.0	–	–	HD8S	47810
9/16"	1-1/16"	14.3	27.0	HD10H	47921	HD10S	47811
9/16"	1-1/4"	14.3	31.7	HD12H	47922	HD12S	47812
11/16"	1-1/2"	17.5	38.1	HD16H	47923	HD16S	47813
3/4"	1-3/4"	19.0	44.4	HD20H	47924	HD20S	47814
1-1/16"	2"	27.0	50.8	HD24H	47925	HD24S	47815
1-5/16"	2-1/4"	33.3	57.1	HD28H	47926	HD28S	47816
1-9/16"	2-1/2"	39.7	63.5	HD32H	47927	HD32S	47817
1-13/16"	2-3/4"	46.0	69.8	HD36H	47928	HD36S	47818
2-1/16"	3"	52.4	76.2	HD40H	47929	HD40S	47819
2-5/16"	3-1/4"	58.7	82.5	HD44H	47930	HD44S	47820
2-9/16"	3-1/2"	65.1	88.9	HD48H	47931	HD48S	47821
2-13/16"	3-3/4"	71.4	95.2	HD52H	47932	HD52S	47822
3-1/16"	4"	77.8	101.6	HD56H	47933	HD56S	47823
2-1/2"	4-1/2"	63.5	114.3	HD64H	47934	HD64S	47824
3"	5"	76.2	127.0	HD72H	47935	HD72S	47825
3-1/2"	5-1/2"	88.9	139.7	HD80H	47936	HD80S	47826
4"	6"	101.6	152.4	HD88H	47937	HD88S	47827
4-1/2"	6-1/2"	114.3	165.1	HD96H	47938	HD96S	47828
5"	7"	127.0	177.8	HD104H	47939	HD104S	47829

Collared Screw Hose Clamps

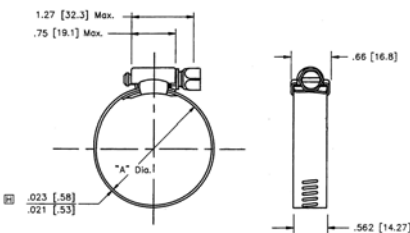
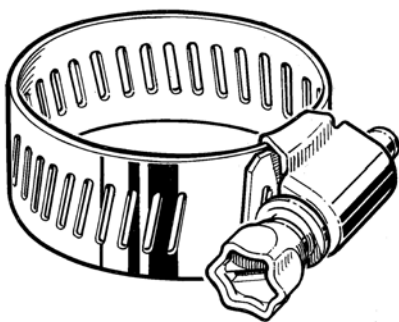

- 3/8" safety collared, hex-head screw eliminates danger of screw driver slipping and damaging the hose
- The combination collared and hex-head screw can be used with blade type and nut drivers as well as socket wrenches
- 9/16" band width offers greater sealing area
- 9/16" 300 series stainless steel band and housing
- 3/8" zinc plated carbon steel, collared, hex-head screw

Collared Screw Hose Clamps

Clamp Diameter					
Fraction		Metric (mm)		Clamp No.	UPC No.
Min.	Max.	Min.	Max.		
3/8"	7/8"	10	22	CS6H	47941
7/16"	1"	11	25	CS8H	47942
1/2"	1-1/8"	13	28	CS10H	47943
1/2"	1-1/4"	13	32	CS12H	47944
3/4"	1-1/2"	19	38	CS16H	47945
3/4"	1-3/4"	19	44	CS20H	47946
1"	2"	26	50	CS24H	47947
1-5/16"	2-1/4"	34	57	CS28H	47948
1-9/16"	2-1/2"	40	64	CS32H	47949
7/8"	2-3/4"	23	70	CS36H	47950
1-1/8"	3"	29	76	CS40H	47951
1-5/16"	3-1/4"	34	82	CS44H	47952
1-5/8"	3-1/2"	42	90	CS48H	47953
1-7/8"	3-3/4"	48	95	CS52H	47954
2-1/8"	4"	54	100	CS56H	47955

9/16" Band – Heavy Duty 4-Piece Hose Clamps

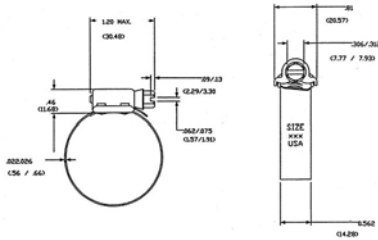

- 9/16" band width offers greater sealing area
- 5/16" slotted hex-head screw
- 300 series stainless steel band, housing & screw
- Heavy duty, four-piece construction
- Two-piece, mechanical interlock housing
- Allows 80 inch pounds of torque
- Wide range of applications including marine, plumbing, agricultural and heavy duty industrial

9/16" Band – Heavy Duty Hose Clamps

Clamp Diameter				All Stainless	
Fraction		Metric (mm)		Clamp No.	UPC No.
Min.	Max.	Min.	Max.		
7/16"	7/8"	11	22	HD6SN	47045
7/16"	1"	11	25	HD8SN	47046
1/2"	1-1/8"	13	29	HD10SN	47047
5/8"	1-1/4"	16	32	HD12SN	47048
3/4"	1-1/2"	19	38	HD16SN	47049
7/8"	1-3/4"	22	44	HD20SN	47050
1-1/8"	1-15/16"	29	49	HD24SN	47051
1-3/8"	2-3/16"	36	56	HD28SN	47052
1-5/8"	2-7/16"	42	62	HD32SN	47053
1-7/8"	2-11/16"	48	68	HD36SN	47054
2-1/8"	2-15/16"	55	75	HD40SN	47055
2-3/8"	3-3/16"	61	81	HD44SN	47056
2-9/16"	3-7/16"	40	87	HD48SN	47057
2-13/16"	3-11/16"	47	94	HD52SN	47058
2-1/16"	4"	53	101	HD56SN	47059
2-9/16"	4-7/16"	65	113	HD64SN	47060
3-1/16"	4-15/16"	78	125	HD72SN	47061
2-1/2"	5-7/16"	64	138	HD80SN	47062
3"	5-15/16"	77	151	HD88SN	47063
3-1/2"	6-7/16"	89	163	HD96SN	47064
4"	6-15/16"	102	176	HD104SN	47065
5-1/2"	8-7/16"	140	214	B128HSP	35820
6-3/4"	9-11/16"	171	246	B148HSP	35825
7"	9-15/16"	177	252	B152HSP	35827
7-1/2"	10-7/16"	190	265	B160HSP	35830
9-1/2"	12-7/16"	241	315	B192HSP	35835
11-1/2"	14-7/16"	292	366	B224HSP	35840
14"	16-15/16"	355	430	B264HSP	35845

Critical Connection Hose Clamps (Metric Smooth Band)

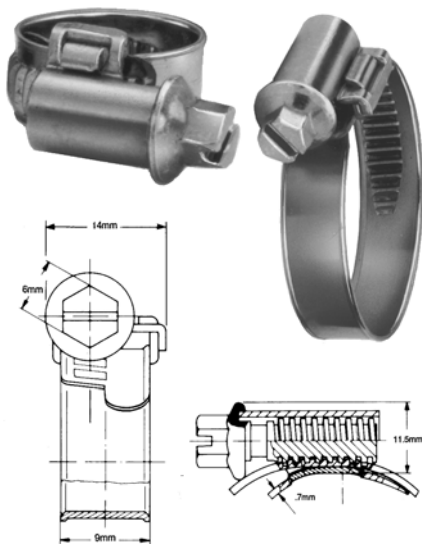

- Short housing saddle is weld free and keyed into the band
- The smooth form evens the pressure around the hose
- Pressed tooth form and rounded, raised band edges prevent damage to the hose
- More efficient sealing at lower torque
- Sold in box quantities of 10

Standard Series

- 9mm band and housing are 400 series stainless steel
- 6mm screw is zinc plated carbon

Miniature Series

- Band and housing are stainless steel
- 5mm slotted hex-head screw is zinc plated carbon

Standard Series Critical Connection Hose Clamps

Clamp Diameter				UPC No.
Metric (mm)		Fraction		
Min.	Max.	Min.	Max.	
12	18	1/2"	11/16"	47000*
8	16	5/16"	5/8"	47070
12	20	1/2"	3/4"	47125
16	25	5/8"	1-1/16"	47155
16	27	5/8"	1"	47185
20	32	3/4"	1-1/4"	47215
25	40	1"	1-5/8"	47245
30	45	1-3/16"	1-3/4"	47275
32	50	1-1/4"	2"	47305
40	60	1-5/8"	2-3/8"	47325
50	70	2"	2-3/4"	47365

* Miniature Series band width is 7.5mm.

316 Stainless Steel Hose Clamps

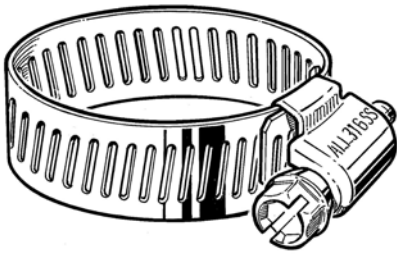

- Non-magnetic, all "316" grade stainless steel construction
- Used in highly corrosive and salt water environments

M-HSPX Series 316 Stainless Micro Clamp

- 5/16" 316 stainless steel band and housing
- 1/4" 316 stainless steel hex-head screw

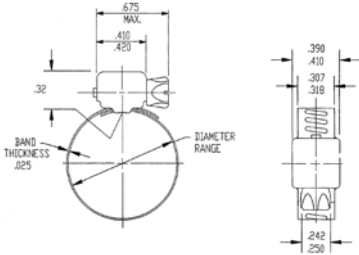

316 Stainless Steel Micro Clamps

Clamp Diameter		Clamp No.	UPC No.		
Fraction	Metric (mm)				
Min.	Max.	Min.	Max.		
7/32"	5/8"	5.6	15.9	M4HSPX	47841
5/16"	7/8"	7.9	22.2	M6HSPX	47842

B-HSPX Series 316 Stainless Clamp

- 1/2" 316 stainless steel band and housing
- 5/16" 316 stainless steel hex-head screw

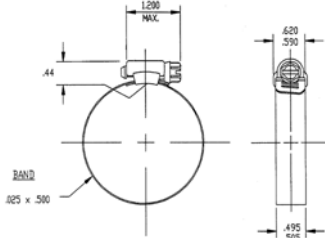

316 Stainless Steel Clamps

Clamp Diameter		Clamp No.	UPC No.		
Fraction	Metric (mm)				
Min.	Max.	Min.	Max.		
3/8"	7/8"	9	22	B6HSPX	47851
7/16"	1"	11	25	B8HSPX	47852
9/16"	1-1/16"	14	27	B10HSPX	47853
9/16"	1-5/16"	14	33	B12HSPX	47854
11/16"	1-1/2"	18	38	B16HSPX	47855
3/4"	1-3/4"	19	44	B20HSPX	47856
1-1/16"	2"	27	51	B24HSPX	47857
1-5/16"	2-1/4"	33	57	B28HSPX	47858
1-9/16"	2-1/2"	40	64	B32HSPX	47859
1-13/16"	2-3/4"	46	70	B36HSPX	47860
2-1/16"	3"	52	76	B40HSPX	47861
2-5/16"	3-1/4"	59	83	B44HSPX	47862
2-9/16"	3-1/2"	65	89	B48HSPX	47863
2-13/16"	3-3/4"	71	95	B52HSPX	47864
3-9/16"	4-1/2"	91	114	B64HSPX	47865
4-1/16"	5"	103	127	B72HSPX	47866
4-5/8"	5-1/2"	118	140	B80HSPX	47867
4-3/32"	6"	104	152	B88HSPX	47868
4-1/2"	6-1/2"	114	165	B96HSPX	47869
5"	7"	127	178	B104HSPX	47870

All Stainless Military Hose Clamps

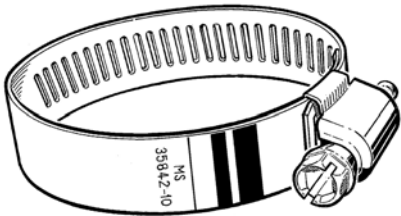

- Manufactured to military standard A-A-52506-B for low pressure type "F" clamps and Federal Specification WW-C-440B
- One-piece, spot weld free housing
- 1/2" 300 series stainless steel band and housing
- 5/16" 300 series stainless steel hex-head screw

All Stainless Military Hose Clamps

Clamp Diameter		Military Std. No.	Clamp No.	UPC No.		
Fraction	Metric (mm)					
Min.	Max.	Min.	Max.			
3/8"	7/8"	9.5	22.2	MS 35842-10	MS6SS	47831
9/16"	1-1/4"	14.3	31.7	MS 35842-11	MS12SS	47832
1-1/16"	2"	27.0	50.8	MS 35842-12	MS24SS	47833
1-13/16"	2-3/4"	46.0	69.8	MS 35842-13	MS36SS	47834
2-9/16"	3-1/2"	65.1	88.9	MS 35842-14	MS48SS	47835
3-5/16"	4-1/4"	84.1	107.9	MS 35842-15	MS60SS	47836
4-1/8"	7"	104.8	177.8	MS 35842-16	MS104SS	47837

WaveSeal 360™ Hose Clamps

WaveSeal 360™ is a registered trademark of Ideal Clamp Products, Inc.

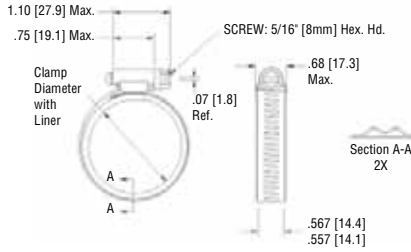

- Unique expansion and contraction creates a steady 360° seal in response to changing temperatures and works well with non-uniform hoses

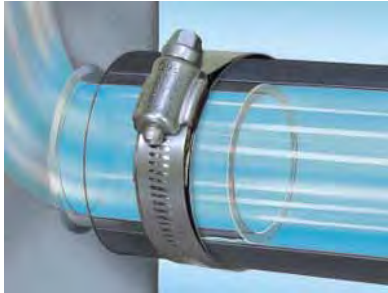

- The two inward pointed ridges form points of high pressure, and between them a low pressure center that creates an o-ring effect



- 9/16" band width (14.29 mm)
- Recent leak pressure tests show that the WaveSeal 360™ clamp performed better in thermal cycling than typical constant tension clamps, Belleville spring or spring-loaded T-bolt styles
- Further testing revealed WaveSeal 360™ performs even better over time when compared to other leading brands in the same category

Common Uses

- Hydraulic systems – construction, agricultural, and telecommunications equipment
- Cooling systems – heater hose, radiator hose and heat exchanger
- Charged Air systems – cold and hot side diesel turbo charger, and air intake



WaveSeal 360™ Clamps

Clamp Diameter				All Stainless	
Decimal		Metric (mm)		Clamp No.	UPC No.
Min.	Max.	Min.	Max.		
.81	1.31	21	33	WS16	47071
1.06	1.38	27	35	WS19	47072
1.03	1.56	26	40	WS20	47073
1.13	1.69	29	43	WS22	47074
1.19	1.81	30	46	WS24	47075
1.34	2.06	34	52	WS28	47076
1.53	2.31	39	59	WS32	47077
1.61	2.44	41	62	WS34	47078
1.69	2.56	43	65	WS36	47079
1.81	2.81	46	71	WS40	47080
2.03	3.06	52	78	WS44	47081
2.19	3.31	56	84	WS48	47082
2.34	3.56	60	91	WS52	47083
2.53	3.81	64	97	WS56	47084
2.69	4.06	68	103	WS60	47085
2.81	4.31	71	110	WS64	47086
3.19	4.81	81	122	WS72	47087
3.53	5.31	90	135	WS80	47088
3.81	5.81	97	148	WS88	47089
4.87	6.81	124	173	WS104	47090

Quick Release Hose Clamps



- The swivel action design of the screw allows for fast and easy adjustments
- These clamps are critical in closed areas where a clamp must be disengaged for installation and removal

QR-H Series - Partial Stainless

- 1/2" 300 series stainless steel band and housing
- 5/16" zinc plated hex-head screw
- 400 series stainless steel bridge

QR-HS Series - All Stainless

- 1/2" 300 series stainless steel band and housing
- 5/16" 400 series stainless steel hex-head screw
- 400 series stainless steel bridge

Quick Release Hose Clamps

Clamp Diameter				Partial Stainless		All Stainless	
Fraction		Metric (mm)		Clamp No.	UPC No.	Clamp No.	UPC No.
Min.	Max.	Min.	Max.				
1/2"	1-1/4"	12.7	31.8	QR12H	47901	QR12HS	47881
3/4"	1-3/4"	19.1	44.4	QR20H	47902	QR20HS	47882
1-1/16"	2"	27.0	50.8	-	-	QR24HS	47883
1"	2-1/4"	25.4	57.1	QR28H	47903	QR28HS	47884
1-1/2"	3-1/2"	38.1	88.9	QR48H	47904	QR48HS	47885
1"	4"	25.4	101.6	QR56H	47905	QR56HS	47886
2"	5"	50.8	127.0	QR72H	47906	QR72HS	47887
2-1/16"	6"	52.4	152.4	QR88H	47907	QR88HS	47888
3-1/2"	6-9/16"	88.9	166.7	-	-	QR96HS	47889
1-3/4"	7"	44.4	177.8	QR104H	47908	QR104HS	47890
1-3/4"	8-9/16"	44.4	217.5	QR128H	47910	QR128HS	47891
2"	10"	50.8	254.0	QR152H	47911	QR152HS	47892
2-1/16"	12-5/16"	52.4	312.7	QR188H	47912	QR188HS	47893
10-3/16"	14"	258.8	355.6	-	-	QR216HS	47894
1-3/4"	16"	44.4	406.4	-	-	QR248HS	47895
14-1/4"	18"	361.9	457.2	-	-	QR280HS	47896
1-7/8"	20"	48.0	508.0	-	-	QR312HS	47897

Create-A-Clamp

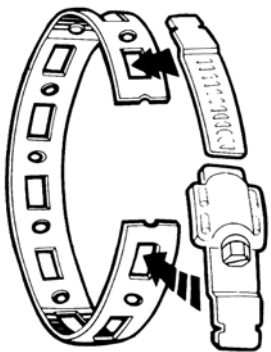

- A quick, easy way to solve almost any clamping problem
- Allows you to economically mount, secure or position as you would with ordinary worm drive clamps in a maintenance environment
- Made of a 300 series stainless steel band, housing and adjustable splices
- The 5/16" hex-head screw is made of a 400 series stainless steel

Create-A-Clamp

Each Box Contains:	UPC No.
Complete set including: 50 ft. of 1/2" Wide Banding 20 Fasteners 10 Splices	41500
Complete set including: 50 ft. of 1/2" Wide Banding 50 Fasteners 10 Splices	41600
Banding only - 50 ft.	41100
Splices only - 10 pieces	41610
Fasteners only - 20 pieces	41620

Unicoil™ Hose Benders/Supports



- Unicoil™ allows you to bend straight hose into any shape and keep it in place
- Helps keep hoses away from hazards, prevents hose kinks and reduces fatigue from repeated bending
- Fast and easy to use, requires no special tools
- Stainless Steel construction will not rust
- Works above or below ground and underwater
- Unicoils™ are reusable...can be bent, straightened and re-bent

Unicoil™

Hose Size	Hose I.D.	Hose O.D.	Unicoil Size	UPC No.	Lb. Wgt.
1/4"	.52"/13mm		8	48500	.04
5/16"	.64"/16mm		10	48505	.05
3/8"	.72"/18mm		12	48510	.08
1/2"	.83"/21mm		13	48515	.09
5/8"	.95"/24mm		15	48520	.11
3/4"	1.09"/28mm		18	48525	.13
1"	1.42"/36mm		23	48530	.19

Unicoil patents and trademarks are held by Unicoil International Pty. Ltd.

- PRECISION BRAND Threaded Rod is made from high quality low carbon steel
- Stainless Steel, high strength B-7 Alloy and Left Hand Threaded Rod are also available
- National Coarse (NC) or National Fine (NF) threads
- Threads are rolled under high pressure for greater strength
- Available in plain oil finish and electro zinc plated
- Other materials, sizes, lengths and special threading available on special order

Plain Oil Finish/National Coarse Threads

Electro Zinc Plated/National Coarse Threads

Size	Wgt. Per 100 Ft.	Plain Oil Finish				Electro Zinc Plated					
		2 ft. * UPC No.	3 ft. UPC Pkg. No. Qty.	6 ft. UPC Pkg. No. Qty.	10 ft. UPC Pkg. No. Qty.	12 ft. UPC Pkg. No. Qty.	2 ft. * UPC No.	3 ft. UPC Pkg. No. Qty.	6 ft. UPC Pkg. No. Qty.	10 ft. UPC Pkg. No. Qty.	12 ft. UPC Pkg. No. Qty.
4 - 40	2.3	27102	27104 10	- -	- -	- -	-	37106 10	- -	- -	- -
5 - 40	3.3	27106	27108 10	- -	- -	- -	-	37110 10	- -	- -	- -
6 - 32	3.7	27110	27114 10	27118 10	- -	- -	37112	37116 10	- -	- -	- -
8 - 32	5.3	27120	27124 10	27128 10	- -	- -	37122	37126 10	- -	- -	- -
10 - 24	7.0	27130	27134 10	27138 10	- -	- -	37132	37136 10	- -	- -	- -
12 - 24	9.6	27152	27156 10	27160 10	- -	- -	37154	37158 10	- -	- -	- -
1/4 - 20	12.6	27162	27166 5	27170 50	27174 50	27178 50	37164	37168 5	37172 50	37176 50	37180 50
5/16 - 18	19.6	27194	27198 5	27202 30	27206 30	27210 30	37196	37200 5	37204 30	37208 30	37212 30
3/8 - 16	28.6	27226	27230 5	27234 25	27238 25	27242 25	37228	37232 5	37236 25	37240 25	37244 25
7/16 - 14	40.0	27258	27262 5	27266 18	27270 18	27274 18	37260	37264 5	37268 18	37272 18	37276 18
1/2 - 13	53.0	27290	27294 5	27298 14	27302 14	27306 14	37292	37296 5	37300 14	37304 14	37308 14
9/16 - 12	67.0	27322	27326 3	27330 12	- -	27334 12	37324	37328 3	37332 12	- -	37336 12
5/8 - 11	84.0	27350	27354 3	27358 8	27362 8	27366 8	37352	37356 3	37360 8	37364 8	37368 8
3/4 - 10	123.0	27382	27386 3	27390 5	27394 5	27398 5	37384	37388 3	37392 5	37396 5	37400 5
7/8 - 9	170.0	27414	27418 3	27422 4	27424 4	27426 4	37416	37420 3	37424 4	37426 4	37428 4
1 - 8	225.0	27442	27446 3	27450 3	27456 3	27454 3	37444	37448 3	37452 3	37458 3	37456 3
1-1/8 - 7	280.0	27470	27474 1	27478 1	- -	27482 1	37472	37476 1	37480 1	- -	37484 1
1-1/4 - 7	350.0	27494	27498 1	27502 1	- -	27506 1	37496	37500 1	37504 1	- -	37508 1
1-3/8 - 6	450.0	27518	27522 1	27526 1	- -	27530 1	37520	37524 1	37528 1	- -	37532 1
1-1/2 - 6	510.0	27542	27546 1	27550 1	- -	27554 1	37544	37548 1	37552 1	- -	37556 1
1-3/4 - 5	700.0	27566	27570 1	27574 1	- -	27578 1	37568	37572 1	37576 1	- -	37580 1
2 - 4-1/2	920.0	27582	27586 1	27590 1	- -	27594 1	37584	37588 1	37592 1	- -	37596 1

National Fine Threaded Rod



Size	Wgt. Per 100 Ft.	Plain Oil Finish				Zinc Plated		
		2 Ft. *	3 Ft.		6 Ft. *	12 Ft. *	3 Ft.	
		UPC No.	Pcs. Per Tube	UPC No.	UPC No.	UPC No.	Pcs. Per Tube	UPC No.
10 - 32	7.3	27142	10	27146	27150	-	10	37148
1/4 - 28	13.6	27182	5	27186	27190	27192	5	37188
5/16 - 24	22.0	27214	5	27218	27222	27224	5	37220
3/8 - 24	32.0	27246	5	27250	27254	27256	5	37252
7/16 - 20	43.0	27278	5	27282	27286	27288	5	37284
1/2 - 20	57.0	27310	5	27314	27318	27320	5	37316
9/16 - 18	73.0	27338	3	27342	27346	27348	3	37344
5/8 - 18	91.0	27370	3	27374	27378	27380	3	37376
3/4 - 16	133.0	27402	3	27406	27410	27412	3	37408
7/8 - 14	182.0	27430	3	27434	27438	27440	3	37436
1 - 14	242.0	27458	3	27462	27466	27468	3	37464
1-1/8 - 12	300.0	27486	1	27488	27490	27492	-	-
1-1/4 - 12	350.0	27510	1	27512	27514	27516	-	-
1-3/8 - 12	450.0	27534	1	27536	27538	27540	-	-
1-1/2 - 12	550.0	27558	1	27560	27562	27564	-	-

* Sold by the individual piece.

Specialty Threaded Rod

Alloy & Specialty Threaded Rod**

Size	Feet Lgth.	Stainless Type 304 UPC No.	B-7 ASTM-193 Gold Zinc Dichromate UPC No.	Left Hand Plain Oil Finish UPC No.	Size	Feet Lgth.	Stainless Type 304 UPC No.	B-7 ASTM-193 Gold Zinc Dichromate UPC No.	Left Hand Plain Oil Finish UPC No.
6 – 32	3	59302	–	–	9/16 – 12	3	–	60327	–
8 – 32	3	59304	–	–	5/8 – 11	3	59330	60331	61330
10 – 24	3	59308	–	–	5/8 – 11	6	59331	60356*	–
10 – 32	3	59306	–	–	5/8 – 11	12	59230	–	–
1/4 – 20	3	59310	60312	61310	5/8 – 18	3	59332	60431	–
1/4 – 20	6	59311	60351*	–	5/8 – 18	6	59333	60365*	–
1/4 – 20	12	59210	–	–	3/4 – 10	3	59334	60336	61334
1/4 – 28	3	59312	60412	–	3/4 – 10	6	59335	60357*	–
1/4 – 28	6	59313	60360*	–	3/4 – 10	12	59234	–	–
5/16 – 18	3	59314	60316	61314	3/4 – 16	3	59336	60436	–
5/16 – 18	6	59315	60352*	–	3/4 – 16	6	59337	60366*	–
5/16 – 18	12	59214	–	–	7/8 – 9	3	59338	60340	61338
5/16 – 24	3	59316	60416	–	7/8 – 9	6	59339	60358*	–
5/16 – 24	6	59317	60361*	–	7/8 – 14	3	59340	60440	–
3/8 – 16	3	59318	60319	61318	7/8 – 14	6	59341	60367*	–
3/8 – 16	6	59319	60353*	–	1 – 8	3	59342	60344	61342
3/8 – 16	12	59218	–	–	1 – 8	6	59343	60359*	–
3/8 – 24	3	59320	60419	61319	1 – 8	12	59242	–	–
3/8 – 24	6	59321	60362*	–	1 – 14	3	59344	60444	–
7/16 – 14	3	59322	60322	61322	1 – 14	6	59345	60368*	–
7/16 – 14	6	59323	60354*	–	1-1/8 – 7	3	–	60397	–
7/16 – 20	3	59324	60422	–	1-1/8 – 8	3	–	60381	–
7/16 – 20	6	59325	60363*	–	1-1/8 – 12	3	–	60481	–
1/2 – 13	3	59326	60325	61326	1-1/4 – 7	3	–	60383	–
1/2 – 13	6	59327	60355*	–	1-1/4 – 8	3	–	60385	–
1/2 – 13	12	59226	–	–	1-1/4 – 12	3	–	60485	–
1/2 – 20	3	59328	60425	61328	1-1/2 – 6	3	–	60387	–
1/2 – 20	6	59329	60364*	–	1-1/2 – 8	3	–	60389	–

* Plain Finish

** Specialty rod sold by the piece.

Metric Threaded Rod



- PRECISION BRAND Metric Threaded Rod is made from a low carbon steel
- Sold by the individual piece

Metric Threaded Rod

Size	Pitch	1 Meter Lengths Zinc Plated UPC No.	1 Meter Lengths Plain Oil Finish UPC No.	3 Meter Lengths Plain Oil Finish UPC No.	Lb. Wgt. Per Meter
M5	.80	79500	79100	79200	.26
M6	1.00	79505	79105	79205	.36
M8	1.25	79510	79110	79210	.70
M10	1.50	79515	79115	79215	1.04
M12	1.75	79520	79120	79220	1.57
M14	2.00	79525	79125	79225	2.19
M16	2.00	79530	79130	79230	2.95
M20	2.50	79535	79135	79235	4.55

Coupling Nuts



- Made of high quality low carbon steel
- Electro zinc plated for long shelf life
- Corrosion resistant
- Standard hex NC thread size
- Nuts have extended length for joining two pieces of rod firmly together
- Bulk, NF and other NC size nuts also available

Coupling Nuts

Size	UPC No.	Pcs. Per Box	Width Across Flats	Length	Pkg. Lb. Wgt.
1/4-20	52110	50	3/8"	7/8"	.98
5/16-18	52115	30	5/8"	1-3/4"	3.39
3/8-16	52120	30	5/8"	1-3/4"	3.58
1/2-13	52130	30	11/16"	1-3/4"	3.82
5/8-11	52135	20	13/16"	2-1/8"	3.04
3/4-10	52140	20	1"	2-1/4"	5.87
7/8-9	52145	10	1-1/4"	2-1/2"	5.91
1-8	52150	10	1-3/8"	2-3/4"	7.30

Drill Rod

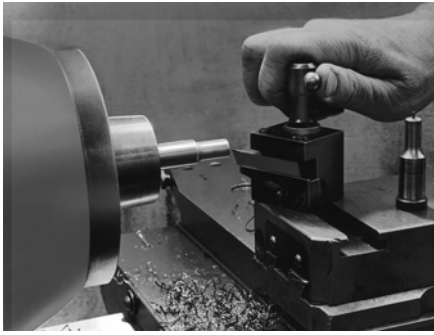

- PRECISION BRAND Drill Rod rounds are made of annealed, ground and polished, general purpose tool steel
- Used for punches, tools and dies, drills, taps, arbors, roller bearings, dowel pins and a variety of machine parts where high strength and long life are required
- Excellent finish, strength and machinability makes drill rod ideally suited for power drive shafts and applications where accuracy and straightness are required
- Stocked in 3 feet lengths
- Available in Water Hardening (W-1) and Oil Hardening (O-1) grades
- Other grades and sizes, including metric are available on special order



Water Hardening/W-1

Color Coded with red ends

- Made from a 1095 steel
- Most popular type
- Most versatile and least expensive
- Tough hardening quality affords optimum response to heat treatment and provides toughness and maximum wear resistance in service
- High carbon content allows it to be used without heat treatment for many maintenance applications
- Fine-grained, electric furnace melt, commercial grade tool steel

Oil Hardening/O-1

Color Coded with yellow ends

- Made from a 1085 steel
- Electric furnace melt tool steel
- Non-shrinking, general-purpose tool steel
- Excellent toughness and machinability characteristics

Hardness Before Tempering (Both W-1 & O-1)

Decimal Diameter	RB	BHN
.063 – .124	110	341
.125 – .249	104	275
.250 – .875	101	241
.876 – 2.00	96	207

W-1 Tempering Data

Temperature °F	RC
As Quenched	66 – 68
300	64 – 65
400	62 – 64
500	58 – 59
600	54 – 56
700	50 – 51
800	46 – 47

O-1 Tempering Data

Temperature °F	RC
As Quenched	63 – 65
300	63 – 65
400	61 – 64
500	60 – 63
600	57 – 60
800	48 – 51
1,000	44 – 48

3 Feet Length Drill Rod

Size	Diameter		Wgt. Per Piece	W-1 Water Hardening UPC No.	O-1 Oil Hardening UPC No.
	Decimal	Metric (mm)			
NO. 52	.063	1.600	.033	18162	28162
NO. 51	.066	1.676	.036	18161	28161
NO. 50	.069	1.753	.039	18160	28160
NO. 49	.072	1.829	.042	18159	28159
NO. 48	.075	1.905	.045	18158	28158
NO. 47	.077	1.956	.048	18157	28157
NO. 46	.079	2.007	.051	18155	28155
NO. 45	.081	2.057	.054	18154	28154
NO. 44	.085	2.159	.057	18153	28153
NO. 43	.088	2.235	.063	18152	28152
NO. 42	.092	2.337	.069	18151	28151
NO. 41	.095	2.413	.072	18149	28149
NO. 40	.097	2.464	.075	18148	28148
NO. 39	.099	2.515	.078	18147	28147
NO. 38	.101	2.565	.084	18146	28146
NO. 37	.103	2.616	.087	18145	28145
NO. 36	.106	2.692	.090	18144	28144
NO. 35	.108	2.743	.093	18143	28143
NO. 34	.110	2.794	.096	18141	28141
NO. 33	.112	2.845	.102	18140	28140
NO. 32	.115	2.921	.108	18139	28139
NO. 31	.120	3.048	.117	18138	28138
NO. 30	.127	3.226	.129	18136	28136
NO. 29	.134	3.404	.144	18135	28135
NO. 28	.139	3.531	.156	18134	28134
NO. 27	.143	3.632	.165	18132	28132
NO. 26	.146	3.708	.171	18131	28131
NO. 25	.148	3.759	.177	18130	28130
NO. 24	.151	3.835	.183	18129	28129
NO. 23	.153	3.886	.189	18128	28128
NO. 22	.155	3.937	.195	18127	28127
NO. 21	.157	3.988	.198	18125	28125
NO. 20	.161	4.089	.207	18124	28124
NO. 19	.164	4.166	.216	18123	28123
NO. 18	.168	4.267	.228	18122	28122
NO. 17	.172	4.369	.237	18120	28120
NO. 16	.175	4.445	.246	18119	28119
NO. 15	.178	4.521	.255	18118	28118
NO. 14	.180	4.572	.261	18117	28117
NO. 13	.182	4.623	.267	18116	28116
NO. 12	.185	4.699	.276	18115	28115
NO. 11	.188	4.775	.282	18113	28113
NO. 10	.191	4.851	.288	18112	28112
NO. 9	.194	4.928	.297	18111	28111

3 Feet Length Drill Rod

Size	Diameter		Wgt. Per Piece	W-1 Water Hardening UPC No.	O-1 Oil Hardening UPC No.
	Decimal	Metric (mm)			
NO. 8	.197	5.004	.312	18110	28110
NO. 7	.199	5.055	.318	18109	28109
NO. 6	.201	5.105	.321	18108	28108
NO. 5	.204	5.182	.327	18106	28106
NO. 4	.207	5.258	.345	18105	28105
NO. 3	.212	5.385	.363	18104	28104
NO. 2	.219	5.563	.387	18102	28102
NO. 1	.227	5.766	.414	18101	28101
A	.234	5.944	.441	18100	28100
B	.238	6.045	.450	18098	28098
C	.242	6.147	.462	18097	28097
D	.246	6.248	.483	18096	28096
E	.250	6.350	.501	18094	28094
F	.257	6.528	.522	18093	28093
G	.261	6.629	.543	18092	28092
H	.266	6.756	.564	18090	28090
I	.272	6.909	.594	18089	28089
J	.277	7.036	.615	18088	28088
K	.281	7.137	.636	18087	28087
L	.290	7.366	.675	18085	28085
M	.295	7.493	.699	18084	28084
N	.302	7.671	.726	18082	28082
O	.316	8.026	.813	18080	28080
P	.323	8.204	.831	18079	28079
Q	.332	8.433	.882	18077	28077
R	.339	8.611	.924	18076	28076
S	.348	8.839	.975	18074	28074
T	.358	9.093	1.026	18073	28073
U	.368	9.347	1.086	18071	28071
V	.377	9.576	1.149	18069	28069
W	.386	9.804	1.200	18068	28068
X	.397	10.084	1.263	18066	28066
Y	.404	10.262	1.281	18065	28065
Z	.413	10.490	1.374	18063	28063
1/16	.0625	1.588	.030	18163	28163
5/64	.0781	1.984	.051	18156	28156
3/32	.0938	2.381	.069	18150	28150
7/64	.1094	2.778	.093	18142	28142
1/8	.1250	3.175	.126	18137	28137
9/64	.1406	3.572	.156	18133	28133
5/32	.1563	3.969	.198	18126	28126
11/64	.1719	4.366	.234	18121	28121
3/16	.1875	4.763	.282	18114	28114
13/64	.2031	5.159	.327	18107	28107

Drill Rod

3 Feet Length Drill Rod

Size	Diameter		Wgt. Per Piece	W-1 Water Hardening UPC No.	O-1 Oil Hardening UPC No.
	Decimal	Metric (mm)			
7/32	.2188	5.556	.387	18103	28103
15/64	.2344	5.953	.441	18099	28099
1/4	.2500	6.350	.501	18095	28095
17/64	.2656	6.747	.561	18091	28091
9/32	.2813	7.144	.639	18086	28086
19/64	.2969	7.541	.702	18083	28083
5/16	.3125	7.938	.780	18081	28081
21/64	.3281	8.334	.861	18078	28078
11/32	.3438	8.731	.939	18075	28075
23/64	.3594	9.128	1.032	18072	28072
3/8	.3750	9.525	1.125	18070	28070
25/64	.3906	9.922	1.221	18067	28067
13/32	.4063	10.319	1.311	18064	28064
27/64	.4219	10.716	1.416	18062	28062
7/16	.4375	11.113	1.530	18061	28061
29/64	.4531	11.509	1.626	18060	28060
15/32	.4688	11.906	1.749	18059	28059
31/64	.4844	12.303	1.875	18058	28058
1/2	.5000	12.700	2.000	18057	28057
33/64	.5156	13.097	2.130	18056	28056
17/32	.5313	13.494	2.250	18055	28055
35/64	.5469	13.891	2.390	18054	28054
9/16	.5625	14.288	2.530	18053	28053
37/64	.5781	14.684	2.670	18052	28052
19/32	.5938	15.081	2.810	18051	28051
39/64	.6094	15.478	3.000	18050	28050
5/8	.6250	15.875	3.130	18049	28049
41/64	.6406	16.272	3.310	18048	28048
21/32	.6563	16.669	3.440	18047	28047
43/64	.6719	17.066	3.560	18046	28046
11/16	.6875	17.463	3.750	18045	28045
45/64	.7031	17.859	3.940	18044	28044
23/32	.7188	18.256	4.130	18043	28043
47/64	.7344	18.653	4.310	18042	28042
3/4	.7500	19.050	4.500	18041	28041
49/64	.7656	19.447	4.690	18040	28040
25/32	.7813	19.844	4.880	18039	28039
51/64	.7969	20.241	5.120	18038	28038

3 Feet Length Drill Rod

Size	Diameter		Wgt. Per Piece	W-1 Water Hardening UPC No.	O-1 Oil Hardening UPC No.
	Decimal	Metric (mm)			
13/16	.8125	20.638	5.250	18037	28037
53/64	.8281	21.034	5.480	18036	28036
27/32	.8438	21.431	5.690	18035	28035
55/64	.8594	21.828	5.910	18034	28034
7/8	.8750	22.225	6.130	18033	28033
57/64	.8906	22.622	6.350	18032	28032
29/32	.9063	23.019	6.560	18031	28031
59/64	.9219	23.416	6.790	18030	28030
15/16	.9375	23.813	7.000	18029	28029
61/64	.9531	24.209	7.250	18028	28028
31/32	.9688	24.606	7.590	18027	28027
63/64	.9844	25.003	7.750	18026	28026
1	1.0000	25.400	8.000	18025	28025
1-1/32	1.0313	26.194	8.500	18024	28024
1-1/16	1.0625	26.988	9.030	18023	28023
1-3/32	1.0938	27.781	9.580	18022	28022
1-1/8	1.1250	28.575	10.125	18021	28021
1-5/32	1.1563	29.369	10.700	18020	28020
1-3/16	1.1875	30.163	11.310	18019	28019
1-7/32	1.2188	30.956	11.900	18018	28018
1-1/4	1.2500	31.750	12.500	18017	28017
1-9/32	1.2813	32.544	13.120	18016	28016
1-5/16	1.3125	33.338	13.800	18015	28015
1-11/32	1.3438	34.131	14.450	18014	28014
1-3/8	1.3750	34.925	15.150	18013	28013
1-13/32	1.4063	35.719	15.820	18012	28012
1-7/16	1.4375	36.513	16.540	18011	28011
1-15/32	1.4688	37.306	17.260	18010	28010
1-1/2	1.5000	38.100	18.000	18009	28009
1-9/16	1.5625	39.688	19.560	18008	28008
1-5/8	1.6250	41.275	21.150	18007	28007
1-11/16	1.6875	42.863	22.800	18006	28006
1-3/4	1.7500	44.450	24.510	18005	28005
1-13/16	1.8125	46.038	26.310	18004	28004
1-7/8	1.8750	47.625	28.140	18003	28003
1-15/16	1.9375	49.213	30.060	18002	28002
2	2.0000	50.800	32.040	18001	28001

Measurement Conversion Chart

Fraction	Decimal	Metric (mm)	Fraction	Decimal	Metric (mm)	Fraction	Decimal	Metric (mm)
	.001	.0254	7/32	.21875	5.5563	3/4	.75	19.05
	.0015	.0381	15/64	.234375	5.9531	49/64	.765625	19.4469
	.002	.0508		.2362	6	25/32	.78125	19.8438
	.0025	.0635	1/4	.25	6.35		.7874	20
	.003	.0762	17/64	.265625	6.7469	51/64	.796875	20.2406
	.0035	.0889		.2756	7	13/16	.8125	20.6375
	.0039	.1	9/32	.28125	7.1438		.8268	21
	.004	.1016	19/64	.296875	7.5406	53/64	.828125	21.0344
	.005	.1270	5/16	.3125	7.9375	27/32	.84375	21.4313
	.006	.1524		.3150	8	55/64	.859375	21.8281
	.007	.1778	21/64	.328125	8.3344		.8661	22
	.0079	.2	11/32	.34375	8.7313	7/8	.875	22.225
	.008	.2032		.3543	9	57/64	.890625	22.6219
	.009	.2286	23/64	.359375	9.1281		.9055	23
	.010	.2540	3/8	.375	9.525	29/32	.90625	23.0188
	.0118	.3	25/64	.390625	9.9219	59/64	.921875	23.4156
	.012	.3048		.3937	10	15/16	.9375	23.8125
	.0135	.3429	13/32	.40625	10.3188		.9449	24
	.015	.3810	27/64	.421875	10.7156	61/64	.953125	24.2094
1/64	.015625	.3969		.4331	11	31/32	.96875	24.6063
	.0157	.4	7/16	.4375	11.1125		.9843	25
	.0165	.4191	29/64	.453125	11.5094	63/64	.984375	25.0031
	.018	.4572	15/32	.46875	11.9063	1	1.0	25.4
	.0197	.5		.4724	12			
	.020	.5080	31/64	.484375	12.3031			
	.0236	.6	1/2	.5	12.7			
	.025	.6350		.5118	13			
	.0276	.7	33/64	.515625	13.0969			
	.031	.7874	17/32	.53125	13.4938			
1/32	.03125	.7938	35/64	.546875	13.8906			
	.0315	.8		.5512	14			
	.0354	.9	9/16	.5625	14.2875			
	.0394	1	37/64	.578125	14.6844			
3/64	.046875	1.1906		.5906	15			
1/16	.0625	1.5875	19/32	.59375	15.0813			
5/64	.078125	1.9844	39/64	.609375	15.4781			
	.0787	2	5/8	.625	15.875			
3/32	.09375	2.3813		.6299	16			
7/64	.109375	2.7781	41/64	.640625	16.2719			
	.1181	3	21/32	.65625	16.6688			
1/8	.125	3.175		.6693	17			
9/64	.140625	3.5719	43/64	.671875	17.0656			
5/32	.15625	3.9688	11/16	.6875	17.4625			
	.1575	4	45/64	.703125	17.8594			
11/64	.171875	4.3656		.7087	18			
3/16	.1875	4.7625	23/32	.71875	18.2563			
	.1969	5	47/64	.734375	18.6531			
13/64	.203125	5.1594		.7480	19			

Conversions

1 inch (") = 25.4 millimeters (mm)

1 inch (") = 2.54 centimeters (cm)

1 foot (') = .30481 meters (m)

How to Convert

Inches to millimeters = x 25.4

Inches to centimeters = x 2.54

Feet to meters = x .30481

Millimeters to inches = ÷ 25.4

Centimeters to inches = ÷ 2.54

Meters to feet = ÷ .30481

Notes



THE FIRST AND ONLY SHIM THAT HAS EVERYTHING YOU NEED TO KNOW... RIGHT ON THE SHIM!

Precision Brand's Branded® Shim is the ultimate improvement in shim stock. It's the first and only shim that has the material type, size, thickness, and a tracing lot number printed right on the surface for fast and convenient identification!

No micrometer required!

Imagine the savings in time and money when using Branded® Shim!

AVAILABLE ONLY FROM PRECISION BRAND®

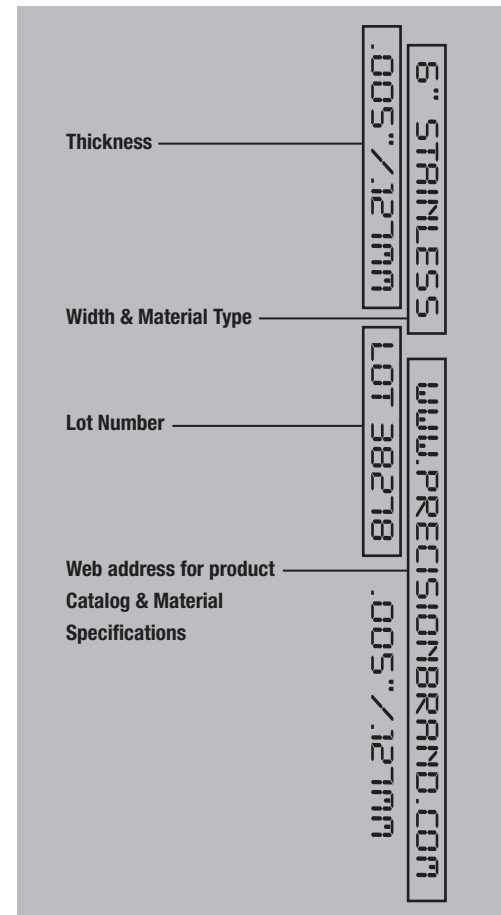

www.precisionbrand.com



Precision Brand Products, Inc.

A subsidiary of Precision Steel Warehouse, Inc.

2250 Curtiss Street

Downers Grove, Illinois 60515 USA

Phone: (630) 969-7200

Fax: (630) 969-0310

Web: www.precisionbrand.com

E-mail: precisionbrand@pbrand.com

www.precisionbrand.com